

KUBA PLAIN



nicoline

Descrizione modello - *Model Description*

Dimensioni - *Dimensions*

Composizioni consigliate - *Recommended compositions*

nicoline.it

ITALY - C.da Parchi Calia sn Z.I. - 70022 Altamura – BA - Telefono: +39 080 3101487
UNITED STATES - Nicoline Salotti Inc. po box 38783 - Greensboro – NC 27438 - Phone: +1 (336) 259 9881
SINGAPORE - 23 Genting Road #06-01 - Chevalier House Singapore 349481 - Telefono: +65 8168 3354

KUBA PLAIN

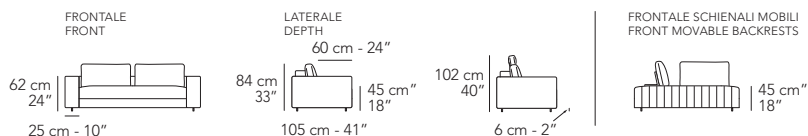

Caratteristiche standard

- Struttura in multistrato e massello di abete, molleggio seduta con cinghie elastiche.
- Imbottiture in poliuretano espanso ecologico a cellula aperta e densità differenziate, con parte superiore seduta in Memory foam.
- Cuscini di schienale in fibra "Extra soft".
- (*) Tutte le versioni con schienale dispongono di elemento reggi schienale.
- Rivestimento in pelle con cuscini di seduta e spalliera sfoderabili.
- Solo per il mercato ITALIA il rivestimento in tessuto è completamente sfoderabile.
- Elementi Cod.9505 - 9508 con basamento rivestito e ripiano in legno nella finitura: Terra (Cod.LTE).
- Piede in metallo RAL 9005.
- Gli elementi Cod.9025 - 9026 sono schienali indipendenti resi stabili da una struttura posteriore in metallo rivestita e posizionabili liberamente sulle versioni "M" e "DM" appartenenti al gruppo "Versioni schienali mobili".
- Cucitura Cod.03 + Cod.01 per rivestimento in pelle.
- Cucitura Cod.03 per rivestimento in tessuto.
- Cucitura Cod.04 su bordo della struttura in metallo per rivestimento in pelle o tessuto degli elementi Cod. 9025-9026.
- Inserimento letto non possibile.
- Lato componibile rifinito.

Caratteristiche optional su richiesta senza maggiorazione

- (*) Nessuna maggiorazione per reggi schienale in materiale o colore differente dal rivestimento principale.
- Disponibile con cucitura a contrasto, per la scelta del colore fare riferimento ai codici del campionario pelli.

Caratteristiche optional su richiesta con maggiorazione

- Poggiatesta (Cod.9900) con imbottitura in poliuretano espanso e supporto in metallo rivestito.
- Per il multi rivestimento il prezzo va incrementato del 7%, per tutte le versioni, incluse cod.9025 e cod.9026. Per maggiori dettagli fare riferimento al paragrafo "NOTE" posto nelle prime pagine del listino.
- Per le versioni Cod.4231 - 4232, 4031 - 4032 e 4004 può essere richiesto un cuscino di schienale aggiuntivo Cod.9015 e relativo reggi schienale Cod.9940.

Note

- I disegni grafici che riportano l'asterisco (*) sono sempre con lato rifinito e anche agganciabili agli elementi componibili.
- Per ogni cuscino schienale (Cod. 9019-9016-9015-9011) del gruppo "elementi di ricambio/optional" è consigliabile aggiungere relativo reggi schienale cod.9940.
- Non è possibile applicare altre cuciture.
- Per alcuni tessuti e velluti l'azienda si riserva di applicare la cucitura Cod.00 / Cod.03 (vedi immagine).

Standard features

- Frame: wooden structure and solid fir wood and seat suspensions in reinforced elastic webbing.
- Paddings in eco-friendly open cell polyurethane foam, with different densities and top of seat cushions with memory foam.
- Back cushions in "Extra soft" fiber.
- All versions with backrest include backrest support (*).
- Covering in leather or fabric. Seat and back cushions coverings removable.
- Versions Cod.9505-9508 with covered base and wooden top in the following finishing: Earthy (Cod.LTE).
- Metal legs in RAL 9005.
- Versions Cod.9025-9026 are free-standing backrests stabilized by a covered metal back frame that can be freely placed on the "M" and "DM" versions of the "adjustable backrest versions" group.
- Stitching type Cod.03 + Cod.01 for leather covering.
- Stitching type Cod.03 for fabric covering.
- Stitching type Cod.04 on the metal structure edge for leather or fabric covering of the versions Cod.9025-9026.
- No bed version available.
- Sectional sides finished.

Optional features available upon request with no upcharge

- (*) No upcharge for back support in a different colour from the main covering.
- Stitching, unless differently requested, will be matching the leather or fabric colour. Contrast stitching colour can be ordered at no extra charge. You might use as reference any Noline leather.

Optional features available upon request with an upcharge

- Headrest (Cod.9900) with polyurethane foam padding and covered metal support.
- 7% upcharge for combined coverings for all the versions, Cod.9025 - 9026 included. Please refer to the notes at the beginning of pricelist.
- Versions Cod.4231 - 4232, 4031 - 4032 and 4004 available with an additional back cushion Cod.9015 and its back support Cod.9940.

Notes

- Versions with asterisk (*) have always the terminal side finished with the possibility to be connected to modular elements.
- For each back cushion (Cod. 9019-9016-9015-9011) of the group "spare or optional parts" we suggest adding its back support Cod.9940.
- Different stitchings not available.
- For some fabrics and velvets production dept. must apply the stitching Cod.00 / Cod.03 (as per picture below).



Tavolino //
Coffee table



Terra
Cod.LTE //
Earthy Cod.LTE



Poggiatesta //
Headrest

Cuciture //
Stitching



Cod.00

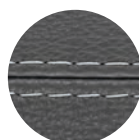

Cod.01

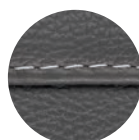

Cod.03

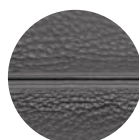

Cod.04

K008 - KUBA PLAIN

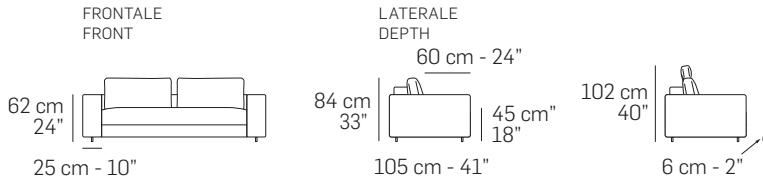

FRONTALE SCHIENALI MOBILI
FRONT MOVABLE BACKRESTS

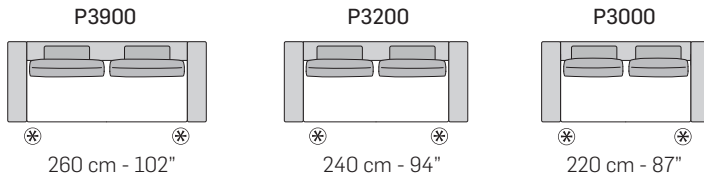
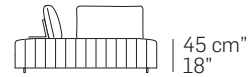

A

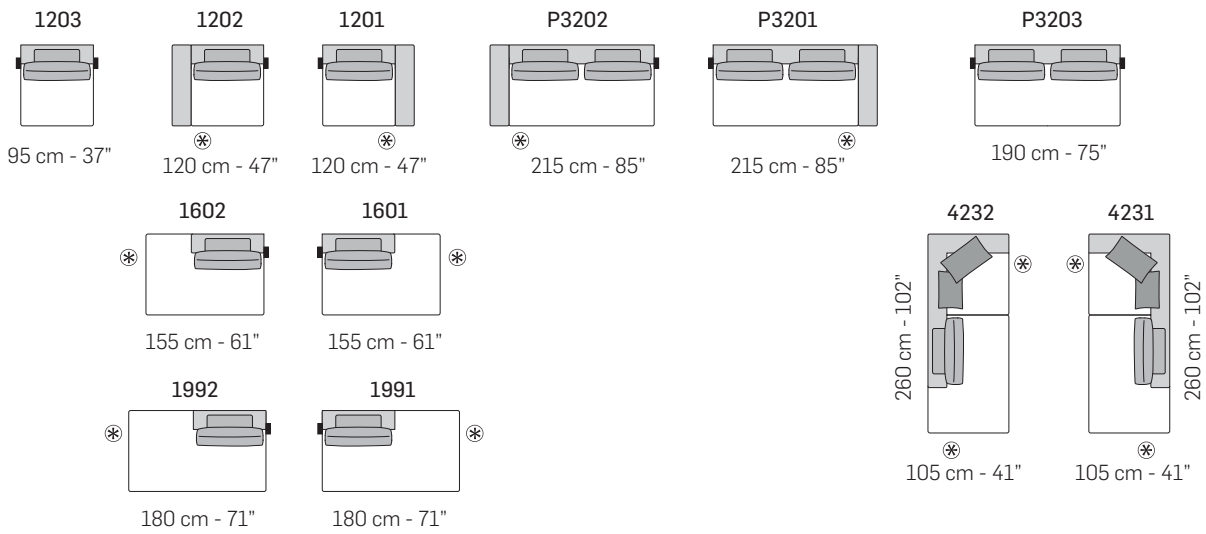

tutti gli elementi del gruppo A hanno lo stesso modulo di seduta - all items in group A have the same seat width

B

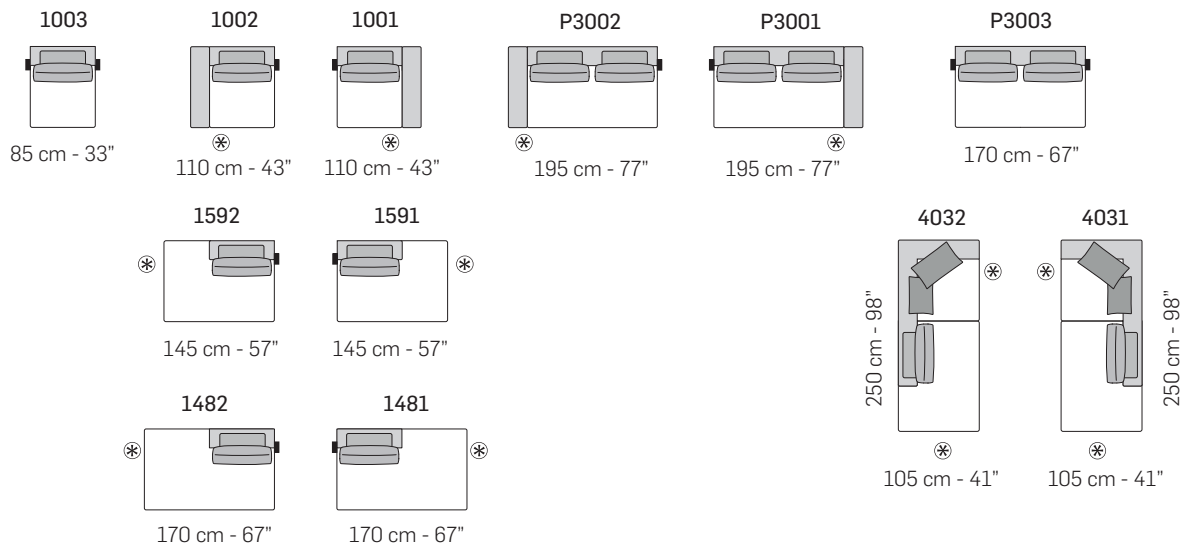

tutti gli elementi del gruppo B hanno lo stesso modulo di seduta - all items in group B have the same seat width

VERSIONI CHAISE-LONGUE / CHAISE LONGUE VERSIONS

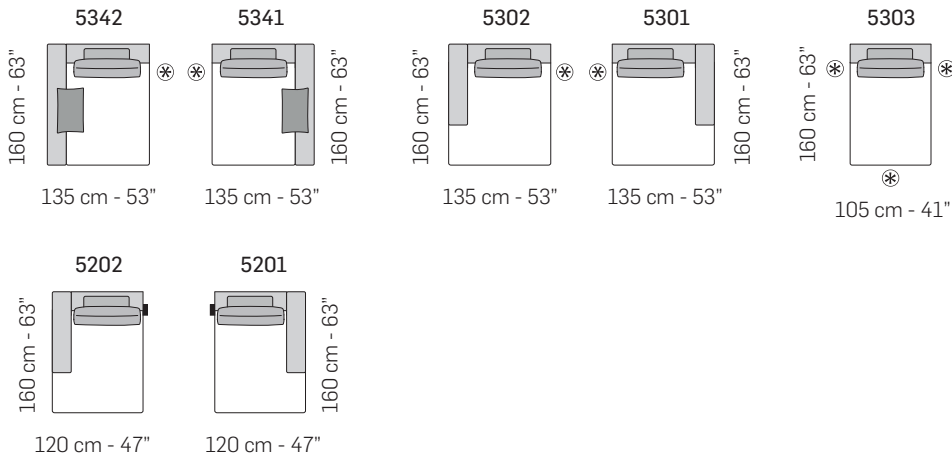

VERSIONI ANGOLARI / CORNER VERSIONS

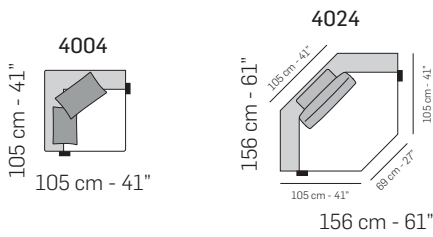

VERSIONI SCHIENALI MOBILI / VERSIONS WITH MOVABLE BACKRESTS

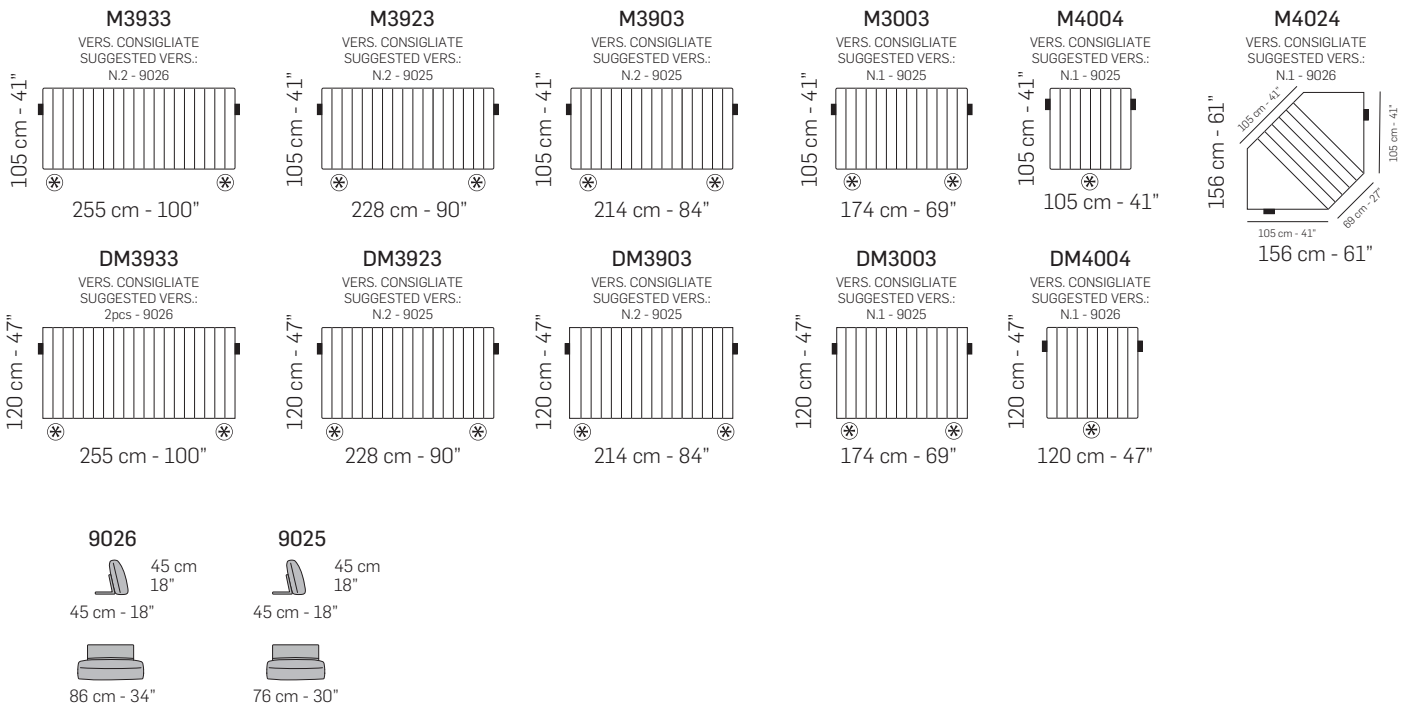

Le versioni 9025 -9026 sono abbinabili solo sulle versioni "M" e "DM" appartenenti al gruppo "Versioni schienali mobili"
 Versions 9025-9026 can be only placed on the "M" and "DM" versions of the "adjustable backrest versions" group

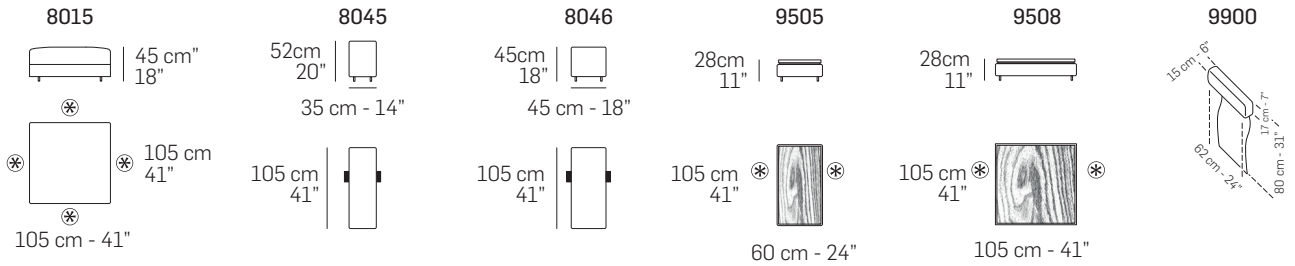

ELEMENTI DI RICAMBIO O OPTIONAL / SPARE OR OPTIONAL PARTS

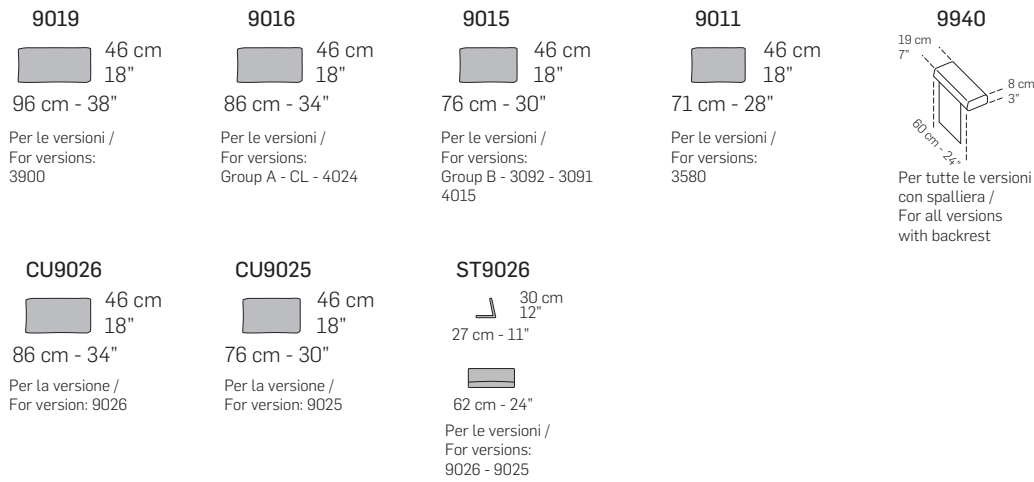

CUSCINETTI CONSIGLIATI / SUGGESTED PILLOWS

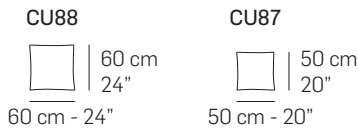

COMPOSIZIONI CONSIGLIATE / SUGGESTED COMPOSITIONS

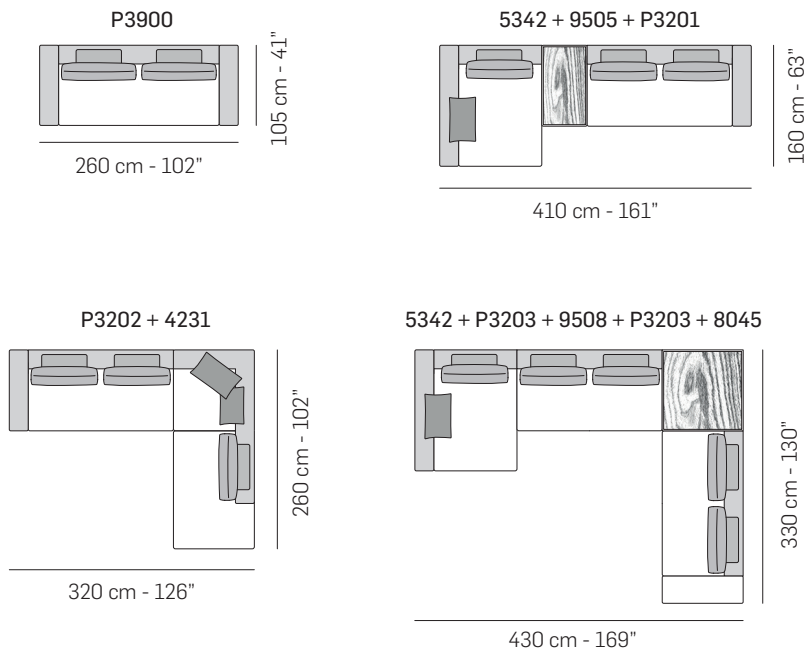

Scala 1:100
Ratio 1 to 100

Legenda / Legend

- Spalliera / Back Cushions
- Bracciolo / Armrest
- Legno / Wood
- Poggiareni / Kidneyrest
- Seduta / Seat Cushions
- Lato terminale sempre rifinito e agganciabile agli elementi componibili / Terminal side is always finished and it can also be connected to modular elements
- Aggancio Componibile / Connector

Note / Notes

Nicoline si riserva il diritto di apportare in ogni momento modifiche tecniche ed estetiche / Nicoline reserves the right to change, at any time and without prior warning, technical and aesthetic specifications of the articles.