

Audo

EPOCH SHELF W/RACK 118

Designed by *Nina Bruun*

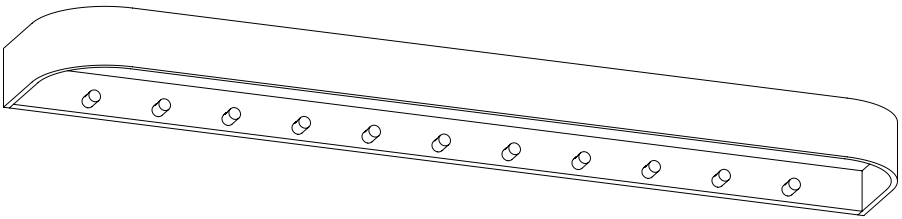

COPENHAGEN

Component overview

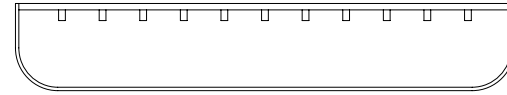

1 x Epoch Rack 118

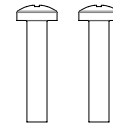

2 x Screws

Tools Needed

Congratulations on your new EPOCH SHELF W/ RACK by *Nina Bruun*. We hope you will enjoy using this item and follow these instructions to ensure correct installation.

These instructions are provided for your safety.

It is important that the instructions are read carefully and completely before assembling.

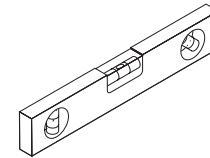

1 x Spirit Level



1 x Pencil

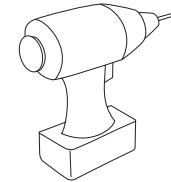

1 x Driller

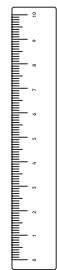

1 x Ruller

Caution

Use screws and wall plugs that are suitable for the walls in your home. If you are uncertain as to which types of screws/wall plugs to use, you should ask your DIY store.

If the Epoch Shelf w/Rack is mounted according to the assembly instruction and the recommendations of screws and wall plugs, Epoch Shelf w/ Rack can handle up to 16 kg.

Care and maintenance

Please see care instructions on www.audocph.com.

1

EPOCH SHELF W/ RACK 118

107,8 cm / 42,4"

3 cm / 1,18"

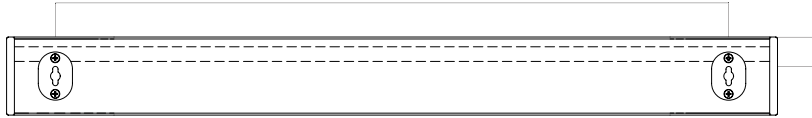

3

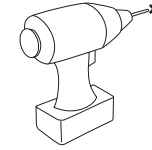

x

2

Mark the hole distance and ensure the holes are in level before drilling.

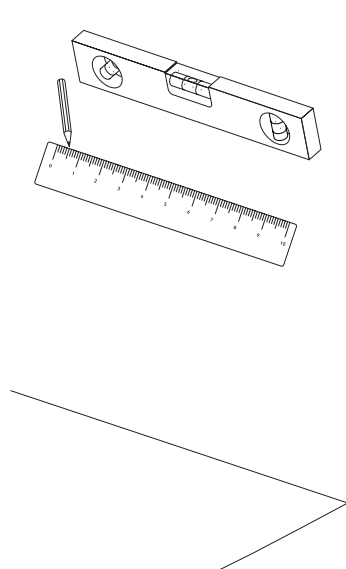

4

