

Kubis Lamp – Tall/Low

Assembly manual

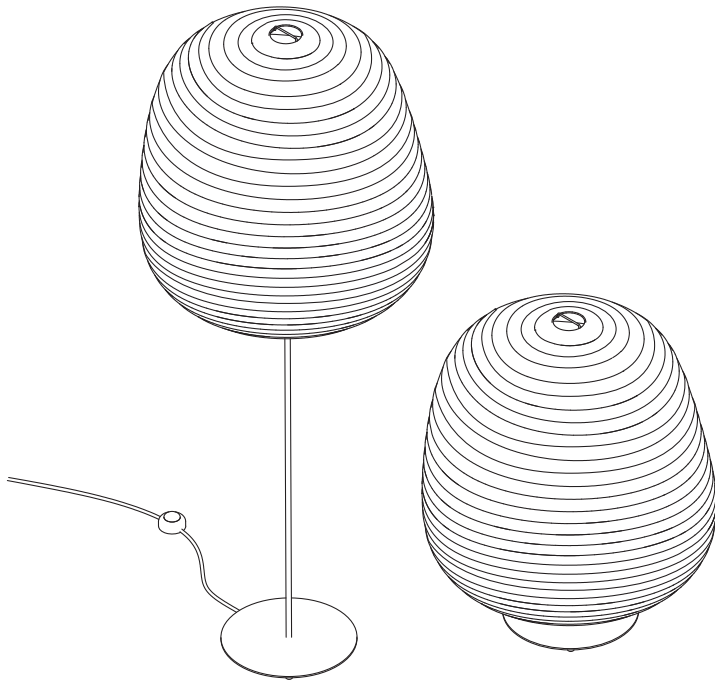

ferm
L I V I N G

General Instructions

PLEASE READ BEFORE INSTALLATION

WARNING:

The safety of this product can only be guaranteed if the following instructions are observed during both installation and use. Please retain these instructions safely after installation.

PLEASE OBSERVE THE FOLLOWING GUIDELINES:

- Ensure that the power supply has been switched off prior to installation or removal of the product.
- Never undertake an electrical installation without the proper knowledge or training. If not familiar with electrical wiring, contact a qualified electrician.
- The product may in no way be modified or tampered with. Any modification may compromise safety and make the product itself dangerous to use. FERM LIVING does not accept any responsibility for products that have been modified.
- This product requires the use of a lightbulb that is not included.
Please use a lightbulb that has the relevant safety certifications and approvals for your area.
- This product is meant for indoor use only.

CLEANING INSTRUCTIONS:

- Use only a soft cloth to clean the product.

MORE INFORMATION:

To access further information such as product overview and material descriptions, please visit our website at www.fermliving.com. If you have any questions or comments, please do not hesitate to contact us at info@fermliving.com.

Technical Specifications

KUBIS FLOOR LAMP

Voltage:	220-240V, 50Hz.
Dimmable:	No
Certification:	CE, IP20, Class II
Socket:	E27 socket base
Recommended light source:	Max 10 watt LED.

Box 1 Content

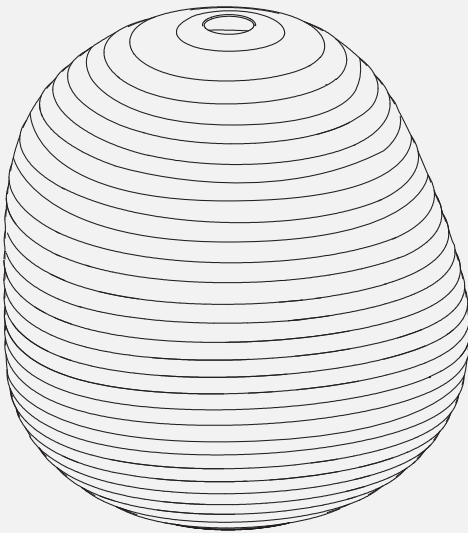

1 x

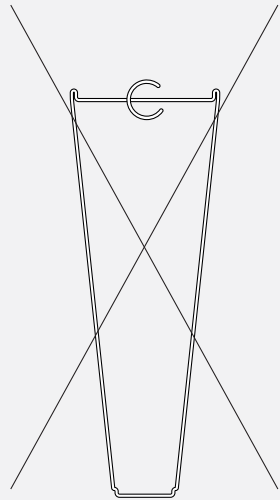

1 x

(Only for pendant. Do not use for floor lamp version.)

Box 2 Content



2 x



1 x

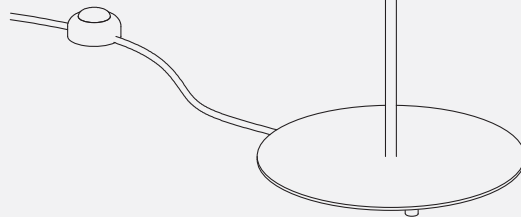

1 x (Tall/Low)

Assembly Process

1

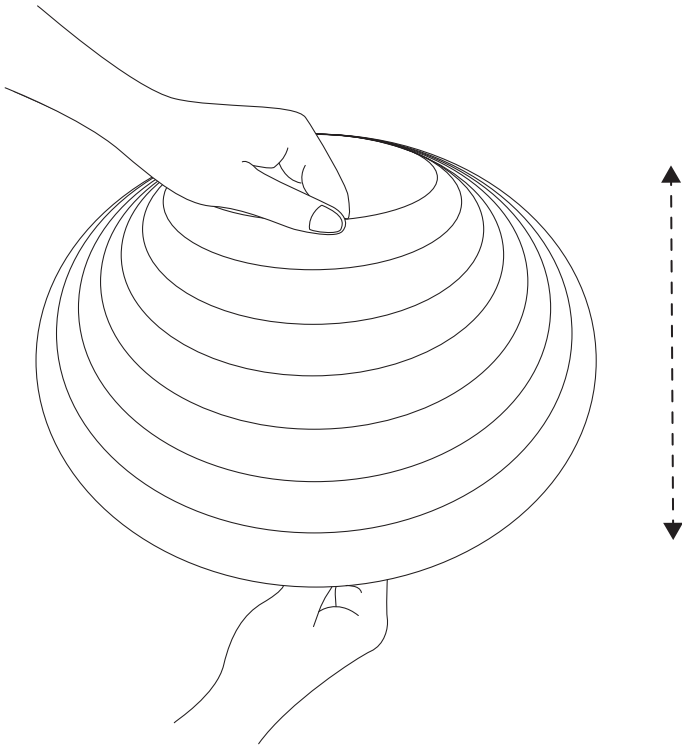

Assembly Process

2

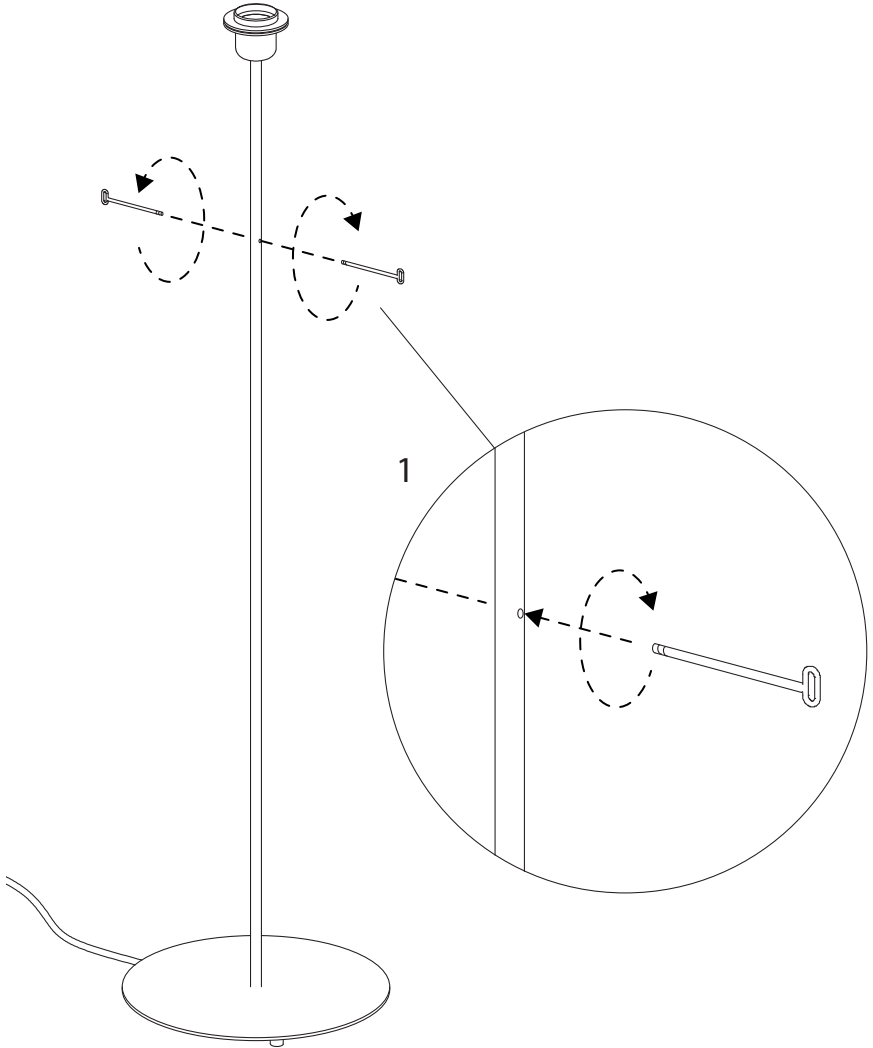

Assembly Process

3

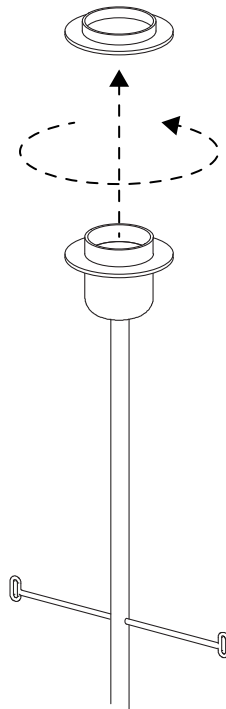

Assembly Process

4

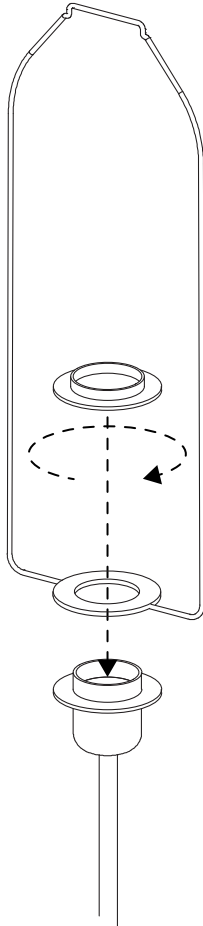

Assembly Process

3

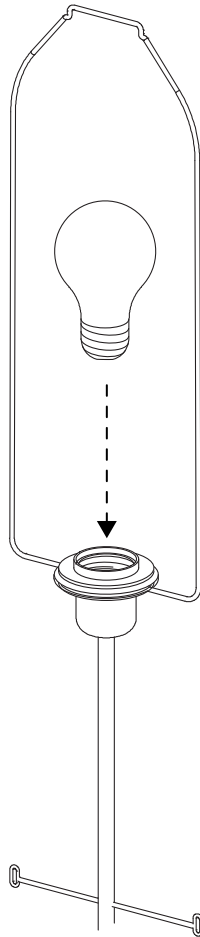

Assembly Process

4

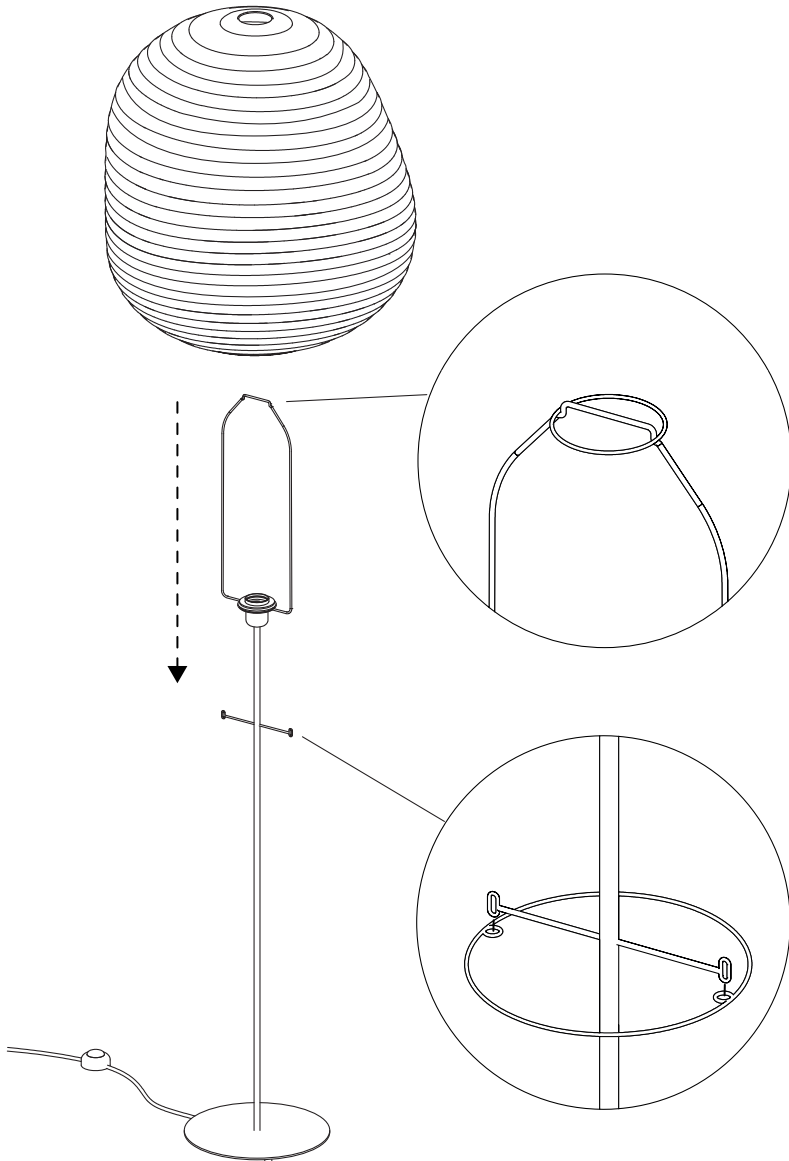

fermliving.com