

creative since 1965
the modular icon by
Fritz Haller & Paul Schärer



73 inspirations for
future-proof work environments

WORK



Price list
Scan the QR code to go to
the price list.

Welcome

- 4 Receptions
- 12 Lobbies and waiting areas

Focus

- 14 Individual workstations
- 26 Remote work

Collaborate

- 32 Team workstations
- 38 Meetings
- 48 Lounges and relaxation

Organise

- 54 Shelving
- 60 Lockers
- 62 Technical zones

Adaptive environments

- 66 USM Haller – to grow with you

Wireless electification

- 68 USM Haller E – for light and charging

Smart desks

- 70 USM Haller – highly customisable
- 72 USM Kitos – ergonomic and energy saving

Privacy & distancing

- 74 USM Privacy Panels – modulate the space

64 What's unique about USM

- 76 Product information
- 78 Product information
- 90 Colours & surfaces

Creating multifunctional spaces sounds so simple but may be a true challenge in times of permanent change. Responding to this with creativity has always been a key strength of USM. For almost 60 years, we have celebrated modularity and fluidity – the ability to adapt to evolving needs at any time; the ability to provide agile yet longlasting solutions for multifunctional, hybrid spaces.

The office as a place to gather for creative exchange and interdisciplinary cooperation will continue to be of central importance in the future. Let's shape it together:

Let's make your office a place that promotes creativity, collaboration and evolves with your company! A place people like to be in! A place that celebrates your organisation's culture and values!

USM Haller is the epitome of timeless design: almost 60 years ago, Fritz Haller and Paul Schärer created a completely new aesthetic – a furniture system inspired by architecture.

Two visionaries, one idea

After completing his engineer studies, Paul Schärer Jr. joined the family business in 1961. The engineer had big ideas: he wanted to build a modern, industrial factory. He partnered with Fritz Haller, a respected architect of Solothurn school.

Born from architecture

Haller developed a flexible construction system with various steel modules. This inspired Paul Schärer Jr., who had a bigger vision: interior design that complements architecture. Together, they developed a modular piece of furniture that was predestined for further development.

Furniture with a system

The centrepiece of the system is a chrome-plated ball with six threaded holes. It connects the chrome-plated steel tubes in any combination. Finally, add sheet steel panels, which are powder-coated in various colours. Everything was intended for the company's own offices.

From prototype to USM Haller

When photos of the forward-thinking furniture system with its innovative aesthetics appeared in architecture journals, it was hailed an international sensation. A commission came from the Rothschild bank in Paris consisting of 600 workstations – the company's first major project. Series production began in 1969.

Less is more

With endless possibilities, the USM Haller system can be configured at will and adjusted to changing requirements, in all directions. Its strikingly fascinating minimalism is eye-catching and inspiring for everyone who values design, quality and functionality.

Modern art

An icon of modern design, USM Haller has been on display at the MoMA in New York since 2001 and recognised as a 'work of applied art' since 1988. USM Haller continues to evolve, while remaining true to itself by retaining original characteristics and invites users to challenge their own creativity.

From Münsingen out into the world

Alexander Schärer has headed up this fourth-generation family business since 2000. Production is still carried out at the headquarters in Münsingen. USM employs 450 people and currently has subsidiaries in the USA, France, Germany, UK, Japan and China. USM products are distributed by dealers in over 40 countries. Sustainability has always been a top priority. In 2008, USM was awarded Greenguard environmental certification and received the Cradle-to-Cradle® environmental label in 2018. The vision is to become a fully circular company by 2030. → S. 76

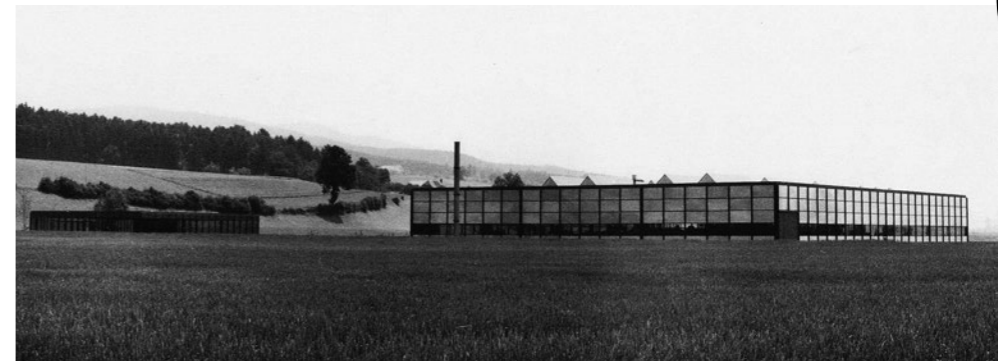

- 1 New factory (1963) and office pavilion (1965) in Münsingen, designed by Fritz Haller.
- 2 In 1965, USM Haller was developed to furnish personal use workspaces within visionary architecture.
- 3 Schärer family home (1969), designed by Fritz Haller, furnished with USM Haller.
- 4 The key to space. Balls, tubes, panels: what began 60 years ago continues to inspire today.

the modular icon by
Fritz Haller & Paul Schärer,
Switzerland

f. haller paul schärer



Welcome

1 A warm arrival
This reception in ruby red sends out a clear signal as a place to meet in the open. Lush worlds of plants serve as semi-transparent zoning and the waiting area invites you to linger.



Welcome

Customise your companies first impression!

A reception has a key role to play: it is the linchpin of an organisation, a place to welcome guests that ensures the right first impression. Often free-standing, it should look good and ideally offer a hospitable waiting area. A USM reception desk is just as individual as a bespoke piece, but it is much more adaptable. The front and back can easily adapt to changing needs with the integration of a showcase, magazine display, privacy screens, USB docking stations and more.



- ↳ 2 **Multifunctional work centre**
This design incorporates a double workstation and high-quality reception in one. Storage compartments are accessible from both sides, so users can access everything they need quickly.
- 3 **A clean appearance**
Sleek from the front, multi-functional from the back, the glass perfectly showcases beautiful items. Customise your reception with drawers and shelves for added organisation.
- ↓ 4 **Simplify interactions**
The reception desk is the essential point of contact for visitors. This fully functional design includes a shelf for bags.
- ↓ 5 **Guest seating**
Combine a long work table with an angled counter to create space for comfortable interactions with your guests.
- ↓ 6 **Barrier-free**
Customise desks with the USM Haller system to allow space for guests, including wheelchair accessible options.



Welcome

7 360° of functionality and design

A USM reception doesn't have a front or a back – it is functional and aesthetically pleasing from all sides. It can easily be retrofitted at any point, for example with safety features. The USM product range offers solutions for almost anything.



Welcome



8 Purity

The reception provides a clutter-free blank canvas which gives a professional first impression for corporate environments.

9 Bring nature inside

Plants can add a touch of greenery to complement the clean lines of the design classic. With a clever solution from USM, you can create a low-maintenance green oasis indoors and provide meeting and waiting rooms with a tranquil setting.



Welcome

Create the perfect reception area!

USM modular furniture is designed to create multi-functional and transitional spaces that no longer have to comply with established typologies. Express your very own corporate culture by designing a completely customised lobby to create a lasting impression.

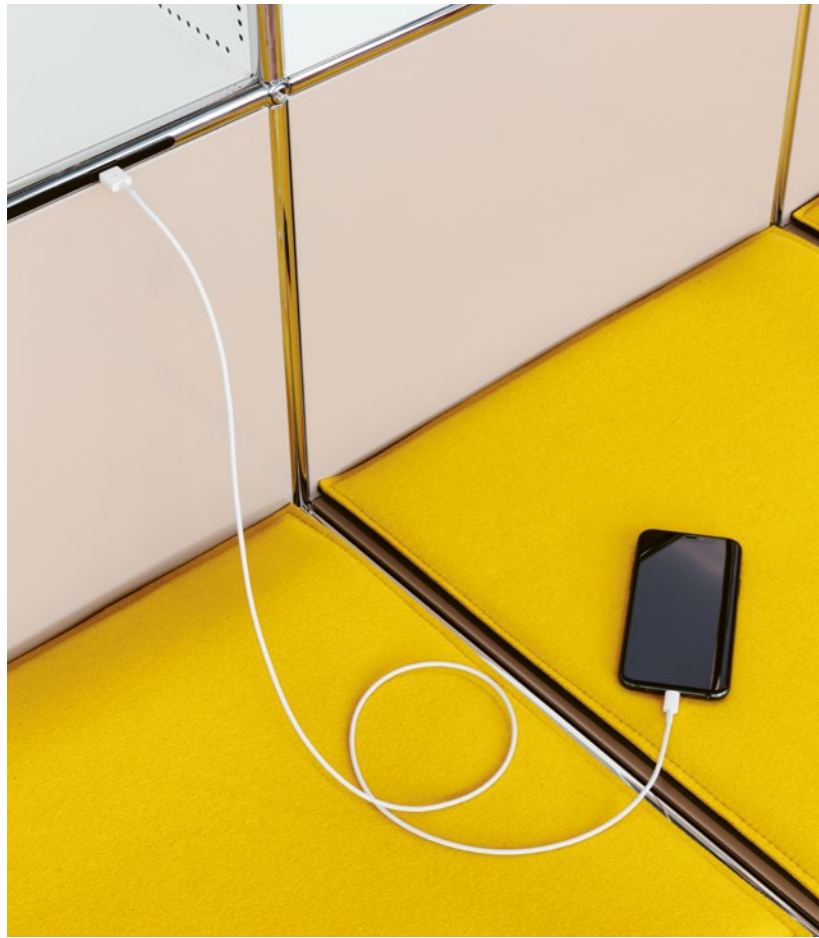

- ↙ 10 **Recharge**
Enable your guests to charge their devices while they wait. The USB charger integrated into the furniture is on hand to help.
- 11 **Multipurpose sculpture**
USM can be used as a spatial divider as well as an eye-catching addition to waiting areas, providing the perfect place for informal get-togethers.
- ↓ 12 **All-in-one**
Plants create a pleasant atmosphere and there's also room to display magazines.
- ↓ 13 **Welcome display**
More than just shelving, this design creates a sense of place in your entrance area. This semi-transparent room divider, which can be used from either side, is the ideal backdrop for your lounge area, with a built-in TV screen.



FOCUS

14 Expressive

High shelving, a long sideboard and a large work desk, all in elegant materials: USM modular furniture offers flexible solutions to meet your needs.



Focus



↙
15 **Sit-stand solution**
The USM Kitos M table is manually height-adjustable. Its elegant black linoleum contrasts beautifully with splashes of colour.

↓
16 **Connectivity**
Added value: The tabletop adaptation points allow for easy connection of accessories such as desk lamps and USB ports and provide access for cables underneath the slidable tabletop.

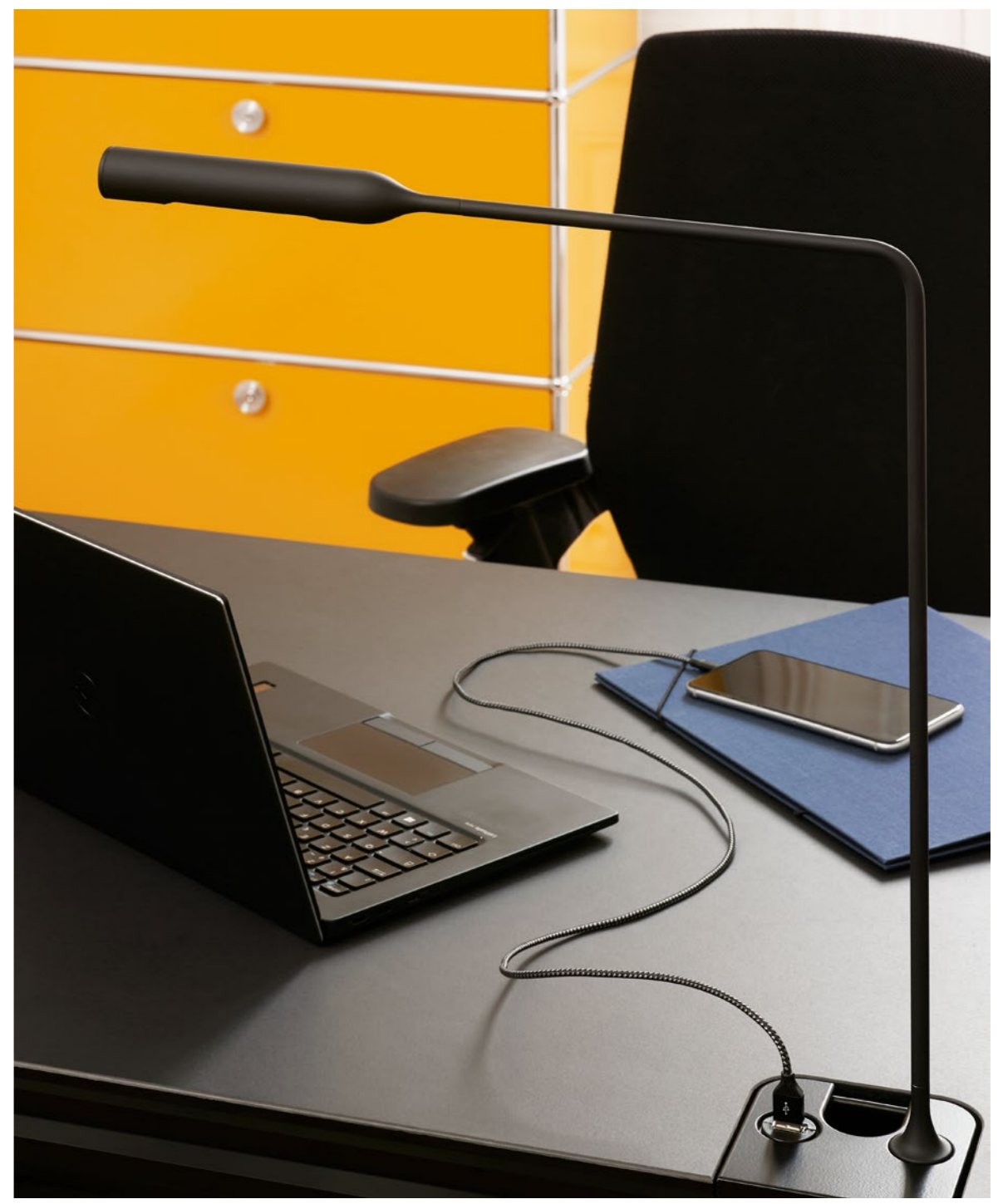

17 Maximum Efficiency
A shared storage unit,
accessible from both sides,
connects two individual
workstations, creating one
surface.

Lock securely, share easily
The storage units can be
locked securely, keeping
confidential documents
safe. With the new electro-
mechanical lock C, you
can now easily manage
access for your colleagues
via the USM app – per-
fect for when you work
remotely.

Focus

The only thing constant is change

USM grows with its owner: When starting a business, what more do you need than a desk and minimal storage? Over time the business and size of your team may grow. Add more functionality step-by-step and align to your business' changing needs.

18 Tear down the walls
Who needs walls when you can easily design room dividers tailored to your team's needs? The gentian blue central unit is a multimedia library and facilitates collaboration.



Focus

Provide space, create privacy!

Longer tables guarantee safe distances between employees. In addition, privacy panels or transparent screens can easily be put up or dismantled in no time at all. Fenix table surfaces are particularly resistant to scratches and fingerprints and are able to withstand regular cleaning.



Versatility

The two tabletop adaptation points allow up to four accessories or protective screens to be easily connected, making it possible to configure the table to meet individual needs.

↙
19 **Protective screens**
Adaptation points on the tabletop enable a wide range of applications. For example, immediately install protective glass screens.

→
20 **Benches with end of desk storage**
Extra-long USM Haller tables combined with USM Privacy Panels create modern team workstations. End of desk storage in a ruby red shade provides space for personal belongings and adds a pop of colour.

↓
21 **Agility**
Work methods may vary, teams change size and structure. The office layout must adapt to evolving needs and projects. USM Privacy Panels can support changing office layouts by dividing up the space.

↓
22 **Functional from all sides**
One table – two workstations. At the impressive three-metre long USM Haller table, plants and USM Privacy Panels can create a sense of privacy without separating employees from their co-workers too much.

21



22



23 Hot desking

Employees can choose a free workstation at the long desk. Computer monitors are mounted in the adaptation points of the USM Haller tables. Simply connect in and off you go.



Focus

Empower your employees to work from home!

Being able to offer a workplace at home is an important argument for attracting top talents nowadays. The advantage of USM: the solutions harmonise with every style of living and available space. A dedicated workplace with an ergonomically height-adjustable table or multi-functional design classic that blends seamlessly into the living environment.



↙
24 **Powerless height-adjustability**
In seconds and with minimal effort, the USM Kitos M desk can be adjusted from a sitting position to a standing one.

→
25 **Ergonomic**
A solution for the sophisticated office: the impressively large 1800 x 900 mm table can be manually height-adjusted using one hand. A brown oiled oak veneer tabletop paired with a playful sideboard creates a homely atmosphere.

↓
26 **Free standing and versatile**
The round, free standing USM Kitos M table is versatile for various purposes. Quickly adjust the height without the need for power or electricity, making for the perfect standing workstation or comfortable breakfast table.

↓
27 **Match making**
The USM Haller modular furniture system can be matched to the USM Kitos table dimensions. No space is ever wasted: storage can be accessed from any side.



26



27



28 Creative repurposing
A table does not necessarily
need four legs. Utilise the
creativity of repurposing:
two timeless sideboards can
be the foundation of a desk
in a league of its own.





↙
29 Office nook
 Elegant and colourful, a home office can be integrated into even the smallest space. The extra narrow, 1250 x 500 mm USM Haller table with black linoleum worksurface doesn't require much room and offers a space-efficient set up.

→
30 A classic with multiple benefits
 A barely visible home office: in the blink of an eye, this stylish sideboard is transformed into a workstation. Push back the extension shelf, put the laptop away, and your work is done for the day.

↓
31 Space miracle
 A compact office in a small space: shelves and pull-outs accommodate all the things needed during a working day. Even a printer can be housed discreetly.

↓
32 Command centre
 Keep everything under control while working from home. Two workstations integrate into a beautiful multifunctional shelf offering generous space for working and a place to put your personal effects.



Collaborate



33 Connecting people

Today's workplace gives users the choice of where and how they want to work. An office space needs to support different ways of working with the ability to come together or meet in a more confidential setting. Large USM Haller tables offer employees greater freedom in how they meet while USM Privacy Panels allow for quiet spaces and central gathering points are created with the USM Haller modular system.

Collaborate

Facilitate collaboration!

Opportunities for spontaneous interactions are essential in the modern-day workplace. From meeting rooms to the cafeteria, from the library to the reception area: USM solutions provide an inspiring atmosphere where visitors feel welcome and teams perform at their peak.



↙
34 **Landscaped offices**
USM Kitos desks provide a flexible office solution for any team. The system enables working individually or in teams, whatever the situation requires. Manual height-adjustment allows for hassle-free flexibility.

→
35 **One team, one table**
Get together at one large desk. USM Haller has three-metre long desks creating work islands in a flexible workspace. Tabletop adaptation points allow maximum individualisation with smart accessories such as lamps, USB ports or protective screens as well as hatches for network access.

↓
36 **Get together**
Two extra-large USM Haller tables are great for spontaneous discussions, meetings or presentations. Everyone simply brings their own USM Haller caddy, containing desk accessories, paperwork and other personal effects necessary for the job.

↓
37 **Office forum**
Create a lounge with built-in storage for breaks or informal meetings with your team.



Collaborate

Create privacy, make rooms flexible!

Free standing USM Privacy Panels are ideal for creating zones within open plan spaces – meeting zones, quiet areas, focus workstations, storage or a welcome area. Each area can be customised by size, height, shape and colour to suit specific functions and needs. Plus, everything can be reconfigured at any time!



- ↙ 38 **Fluid room concepts**
Open plan spaces are easily divided with USM Privacy Panels to enable spontaneous meetings without disturbing others in their work.
- 39 **Optimised acoustics**
USM Privacy Panels have been proven to improve room acoustics, which adds value when dividing open plan spaces into different zones.
- ↘ 40 **Creative village**
USM Privacy Panels offer a modular and flexible way to create breakout areas within a room to enable different types of work to happen in a small space. Add a touch of colour where appropriate.



41 Meeting, presenting, teamwork

The USM Kitos M Meeting extra-large table is manually height-adjustable providing the ideal meeting setting. A media unit holds all the technology.



Collaborate

Provide supersized, height-adjustable tables!

The USM Kitos M Meeting is the first mechanically height-adjustable meeting table that is both supersized and extra stable. Its tension spring mechanism, which lasts much longer than a conventional gas pressure system, adjusts quickly and easily. Optional grommet hatches on both sides allow easy power and network access.



↙
42 **Supersized table**
Enjoy a generously proportioned table at a comfortable height. The USM Kitos M Meeting desk is made for ad-hoc standing meetings of up to eight people and is easily manually height-adjustable.

→
43 **Multipurpose**
Creating inspiring spaces that foster innovation contributes to a dynamic culture. Meeting areas can host video calls, presentations, strategy meetings and even serve as a place to meet with colleagues for a coffee break.

↓
44 **Ad-hoc get together**
Stand and chat in an informal, spontaneous way over a coffee with the USM Kitos M Meeting desk. Plug into the network through two grommet hatches.

↓
45 **Bring your own device**
Personal desk accessories and relevant documents for group projects can easily be stored in a dedicated USM Haller caddy. When the work is done, the USM Haller caddy can simply be placed back in the shelf. The extra-large, 2500 x 1000 mm table provides space for larger meetings.



Collaborate

Make your meetings more dynamic!

Instead of one large conference table and stationary furniture, go with a number of smaller tables and storage furniture on castors. Quickly rearrange the space to exactly the right configuration for any occasion.



↙
46 **Connectivity**
Discreet table grommet hatches allow meeting participants to connect to power and networks at any time.

→
47 **Rearrange!**
Create a versatile and flexible meeting and workshop space for your team: all elements can easily and quickly be rearranged according to what's required.

↓
48 **One group, one table**
Meet in the most stylish way possible: the three-metre long USM Haller table can host up to 8 people.

↓
49 **Screen to the front!**
The screen is the centre of attention in video conference meetings; a sideboard discreetly hides all the technology.



Sound absorption
Perforated metal panels with a fleece-covered interior: acoustic USM Haller elements significantly reduce background noise, thus improving the overall work environment.



Collaborate

50 Multimedia multi-use
Frame screens and technical
equipment with an eye-catch-
ing shelf. Small individual
tables can be moved within
the space for different
meeting configurations.



Collaborate

Cultivate exchange!

The greater the variety of places to meet, the more they will be used. Take advantage of the flexibility of USM by creating spaces within spaces to provide areas for collaboration and concentrated work. Colours and plants bring variety and vitality to these hybrid areas, and built-in lighting creates a welcoming atmosphere.



- ↙ **51 Focus corner**
From the modular system USM Haller, you can also create spaces for focused work or confidential conversations. And thanks to the acoustic panels, the necessary privacy is ensured.
- **52 Meeting spaces**
Smaller format tables can easily be integrated into the office landscape, creating useful spots to meet and converse.
- ↓ **53 Occasional tables**
These free-standing USM Kitos tables can be used for both standing and sitting thanks to the easy height-adjustment.



Collaborate

- ↙ 54 **Recharge**
The perfect place to enjoy a quick snack and recharge your batteries. Literally, thanks to integrated USB charging points.
- 55 **Team space**
This well-designed team space provides a high-quality environment for your employees.
- ↓ 56 **Reading bench**
The ideal spot to sit down and read through the latest inspiring magazines.
- ↓ 57 **Inspirational library**
Customise exactly how you want your library space to look – visit usm.com to configure your space.



56



57



58 Living walls

A freestanding shelf is playfully composed of semi-transparent perforated panels in different heights and depths. The built-in lighting of USM Haller E and a world of plants provide an eye-catching area within the office.



Collaborate



- ↙ 59 **Ready to serve**
This is possibly the most compact tea station in the world: you can even fit in a small refrigerator!
- 60 **Snack bar**
This green USM Haller unit is accessible from both sides. It provides both storage and a countertop which makes it the perfect office kitchen solution. Additional drawers, doors, dividing shelves and smart accessories can also be added.
- ↓ 61 **Coffee station**
This compact sideboard holds everything you need for your coffee station. And if things change, it can easily be reconfigured any time.
- ↓ 62 **Snack counter**
This counter presents a selection of snacks in glass showcases and at the same time creates an attractive bar for people to gather around.

61



62



63 Adaptable system
Framing doors, forming passageways or integrating under slanted ceilings – thanks to its wide range of dimensions and functionalities, and its timeless colours, USM modular furniture has a solution for any location. It can turn any nook into a valuable space.



Organise

Organise



- ↙ 64 **Wall shelving with media outlet**
This USM bookshelf provides an elegant frame around the screen and everything fits flush to the wall with centi-metre precision.
- 65 **Inspirational**
Display brochures or magazines with angled shelves that provide valuable storage space behind them as well.
- ↓ 66 **Freestanding**
A study area can be integrated into a bookshelf.
- ↓ 67 **Playfulness**
Colourful accents turn this shelf with integrated work station into a three-dimensional work of art.

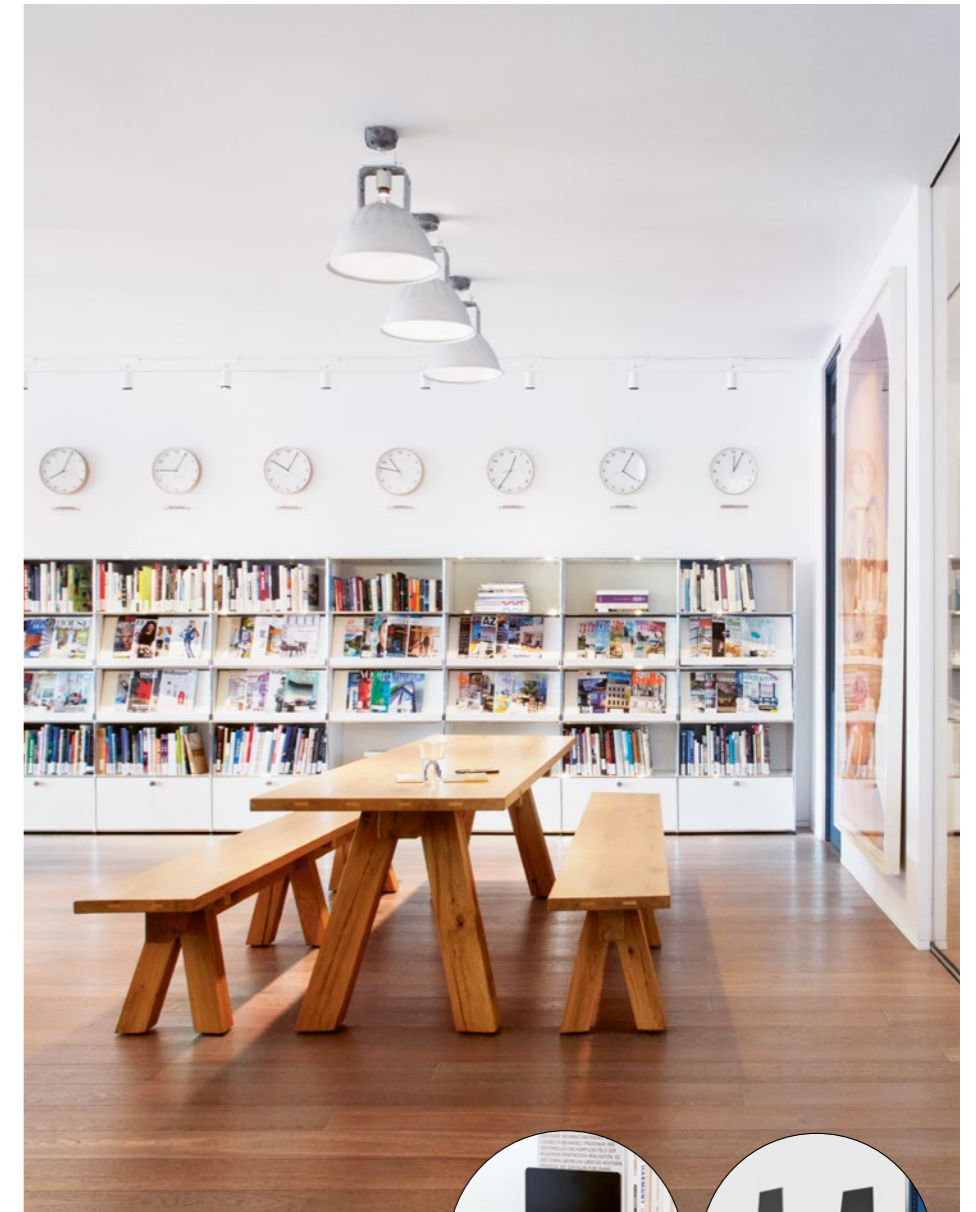

Added storage value
Magnetic or sliding metal bookends make a perfect match for a USM Haller bookshelf. Discover the full range of smart accessories on page 79.

66



67



Organise

Enhance your furniture with plants!

Vibrant colours and lush green plants nurture happiness. We firmly believe that green spaces are the best place to work, live and be together. With the world of plants for USM Haller greenery can be easily integrated in your spaces.



→
68 **World of plants**
Uplift your space by integrating lush greenery with the specially-designed pot elements for USM Haller.

↓
69 **Dividing space, connecting people**
A world of plants structures open plan offices into different spaces without the need for any rigid walls.



69



Connectivity
With the USM app, the new electro-mechanical lock C can be managed intuitively and easily with three different user modes. Keep private items securely locked or allow colleagues to access.

Organise

↙
70 Lockers
Every employee deserves their own storage space – an impressive wall shelving solution.

↓
71 Central storage
The new electromechanical lock C can also be used for extension doors.

↓
72 Mobile storage
This system is available on castors so that teams will always have their personal belongings within reach.

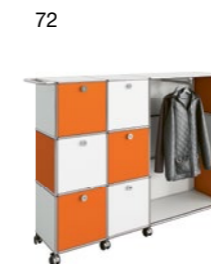

Organise

73 Multifunctional cube
This room-defining unit can be used to house technology such as printers and servers as well as providing shared storage and meeting space for employees.



What's unique about USM

Building future-proof possibilities:

Our core values run deep and permeate every element of what we do – from building furniture to building relationships.



Evolving Design

USM furniture isn't static; it can be reconfigured to follow the evolution of users' needs, even after many years. Whether there are changes in use or size, new components will always be compatible with older USM Haller system products.



Strength and Durability

Produced with the same high quality since its invention almost 60 years ago, the USM Haller system relies on a unique structural system composed of chromed tubes joined by connecting balls and thermo-lacquered panels, resulting in remarkable durability and timeless style.



Adaptation and Innovation

Thanks to its great ease of installation/dismantling, USM furniture is capable of forever adapting itself to the rapid evolution of technical equipment. Retrofittable at any time.



Low Cost of Use

The outstanding durability and adaptability of USM, as well as the possibility of endlessly reconfiguring furniture regardless of initial function, guarantee a reduced cost of use over time.



Sustainable Development and HQE Standards

USM was the first company in Europe to receive the Greenguard international certification by creating furniture that is coherent with the environmental initiatives of buildings. In 2018, USM Haller and USM Kitos M achieved Cradle to Cradle® certification.



Timeless Aesthetic

Invented by architect and industrial visionary Fritz Haller at the beginning of the nineteen sixties, the USM Haller System is characterised by a globally recognised, timeless design that compliments buildings' architecture.



Coherence of furniture

Thanks to its unique modular design, the USM system can meet all furniture needs.

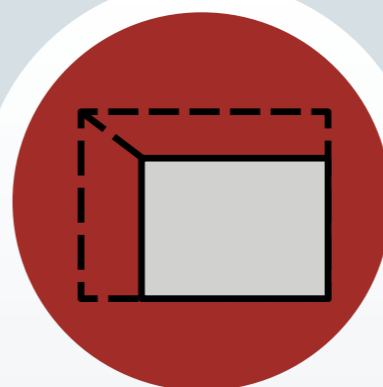

Small Footprint

The strong, sleek and compact structures, achieved by an exemplary quality of construction and choice of materials, allow USM to demonstrate a great conservation of precious space.

Why USM Haller?

- limitless individualisation
- reconfiguration at any time
- simple integration of plants
- optimisation of acoustics
- retrofitting
- a renowned design classic



World of Plants for a healthy climate

Plants improve the indoor climate and thus our working environment. With the world of plants for USM Haller, lively evergreen landscapes can now be easily integrated into the structure of USM Haller.

Smart accessories

Micro organisation: smart accessories complement the design classic. Drawer sets are now available in all 14 standard colours.



Various colour options
14 standard colours support
your individual designs.



Redesign at any time
Our key to modularity lies
in the patented ball-and-tube
connection.



Better acoustics, better atmosphere, less stress

Room acoustics play a decisive role in determining how we feel in our built environment, whether we find the atmosphere pleasant and soothing or stressful and distracting. Where there is less noise, there is less stress and more concentration.



Lock securely, share easily

With the new electromechanical lock C and the specially developed USM app, storage space and lock management take on a whole new dimension.



Why USM Haller E?

- energy-efficient LED ambient and functional light
- almost invisible light source
- USB charger for mobile devices
- wireless and safe power electricity flow through the furniture's own structure



Sensors ensure that light turns on when compartments such as drop-down doors or extension-doors are being opened.

Energy-efficient

24 volts (low voltage) to efficiently provide electricity to the energy-saving, long-lasting LED lights and USB chargers.

Adjustable dimming

The extra-flat transformer is an on-off switch and a dimmer in one. It is located under the piece of furniture.

Two light temperatures

Warm light and cold light – depending on purpose and preference, which can be easily switched at any time.

Modular and future-oriented

Just like everything else about USM Haller, the placement of light sources and chargers is modular – you can turn any desired part of the furniture into a power source. All elements can easily be exchanged. Trained USM sales partners are happy to help you plan or expand your furniture according to your needs.



Seamlessly integrated LED tubes

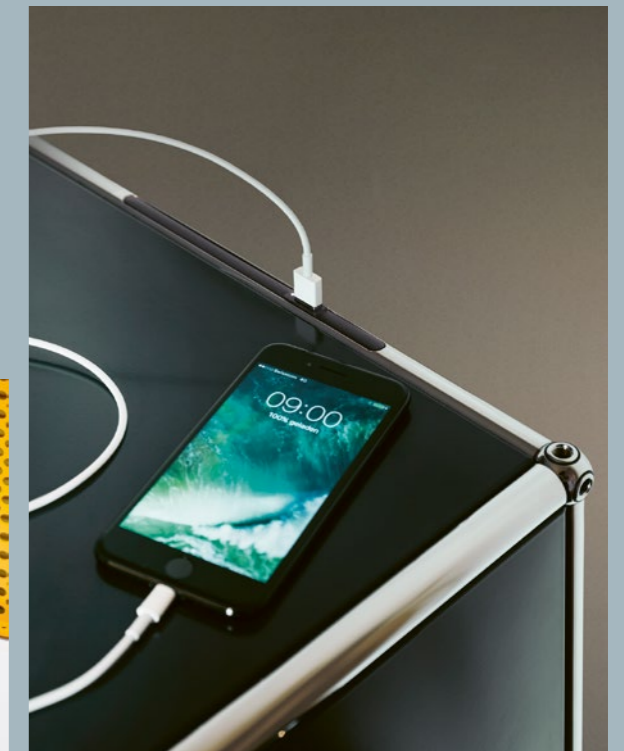

USB charger for charging mobile devices

Why USM Haller desks?

- 4 models
- 20 colours and surfaces
- high individualisation with accessories
- easy electrification
- large range of dimensions from 750 to 3000 mm
- perfect size match with USM Haller system



Various design options
A wide range of colours and materials support your customised designs.



USM Haller



USM Haller Plus



USM Haller Advanced



Side table

Ergonomic

The patented height adjustment system allows the height of this table to be varied continuously in the range from 680 to 860 mm, to meet individual user requirements. This makes the USM Haller table ideally suited for desk sharing.

Versatile

Useful accessories extend the table's functionality and make room for a wide range of applications. An optional grommet hatch integrated into the tabletop gives easy power and network access.

Smart electrification

Electric cables are neatly stowed away in a cable tray under the tabletop and can easily be accessed via hatches, while tabletop adaption points allow additional equipment to be easily plugged in.



Height-adjustability



Smart cable and accessory management



Why USM Kitos?

- 4 models
- 19 colours and surfaces
- high individualisation with accessories
- easy electrification
- immediate mechanical or electric height-adjustment



Various design options
A wide range of colours and materials support your customised designs.



USM Kitos



USM Kitos Plus



USM Kitos Meeting



USM Kitos free-standing

Ergonomic

The electronic or mechanical height-adjustment system used in the USM Kitos M and USM Kitos E allows for both standing and sitting positions and enables the table to be adapted to the personal requirements of its users. Which makes both models ideally suited for desk sharing and hot desking.

Versatile

The two adaption points in the tabletop allow for easy connection of up to four accessories, making it possible to modify the table to meet individual user requirements.

Smart electrification

All cables can properly be stored in a cable tray mounted underneath the tabletop. Depending on the model, the tabletop can be tilted or pushed backwards for easy access to the cables underneath.

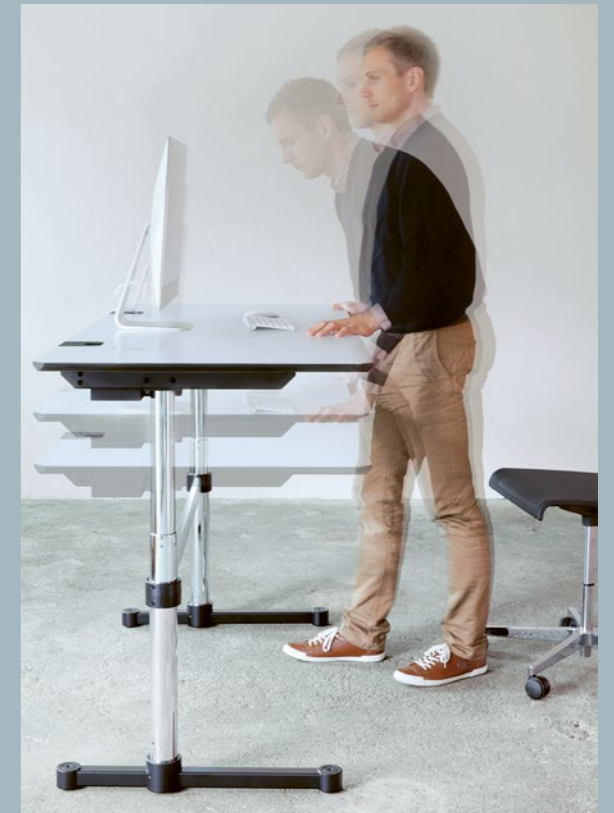

Fast and effortless mechanical height-adjustment.

Intelligent electrification under the movable tabletop; adaption points for USB chargers and other accessories.



Why USM Privacy Panels?

- freestanding for ad-hoc spatial zoning in the open space
- mounted on tables to ensure privacy
- optimised room acoustics
- 5 colours for customisation
- modular system allowing limitless reconfigurations
- perfect size match with USM Haller system and desks

USM Privacy Panels can be used free-standing or mounted on tables to divide up the work space, allowing for more privacy and absorption of unwanted noise.



Modern workspaces
Glass, concrete, open spaces –
an architectural dream, but
a nightmare for acousticians.
USM Privacy Panels help optimise
the acoustics in any room.

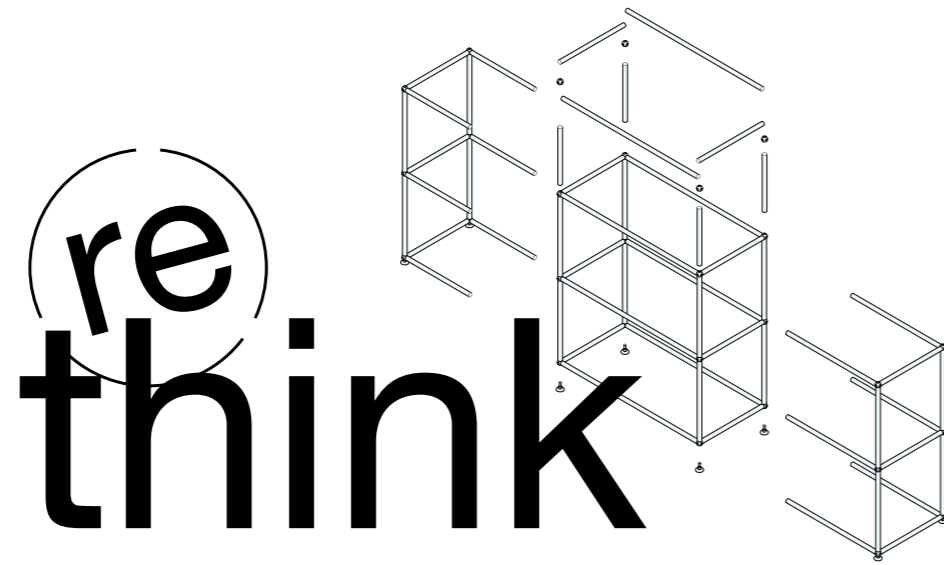

Our vision – becoming a fully circular business
 We want to extend circularity principles beyond our products. That means adopting this philosophy throughout our company – from our product development to our manufacturing, and new business models, from our communications to our supply chain, operations and the expertise of our people.

re
think

Rethink, redesign, revalue sums up the sustainable benefit of our products.

What and how much do you really need? What purposes should a piece of furniture serve? Experienced consultants and virtual planning tools enable us to support you to create a bespoke and conscious purchase. So that you get exactly what you really need, tailored to your current requirements. But don't worry, once furniture has been designed, it can always be rethought and adapted to new circumstances.

Each piece is unique, planned and assembled especially for you. Our furniture is designed to be forever reconfigured. Thanks to the high-quality finish and clever design, all components can be change and extended at any time without any problems. This leads to limitless creative freedom, more individuality in design and almost infinite cycles of use.

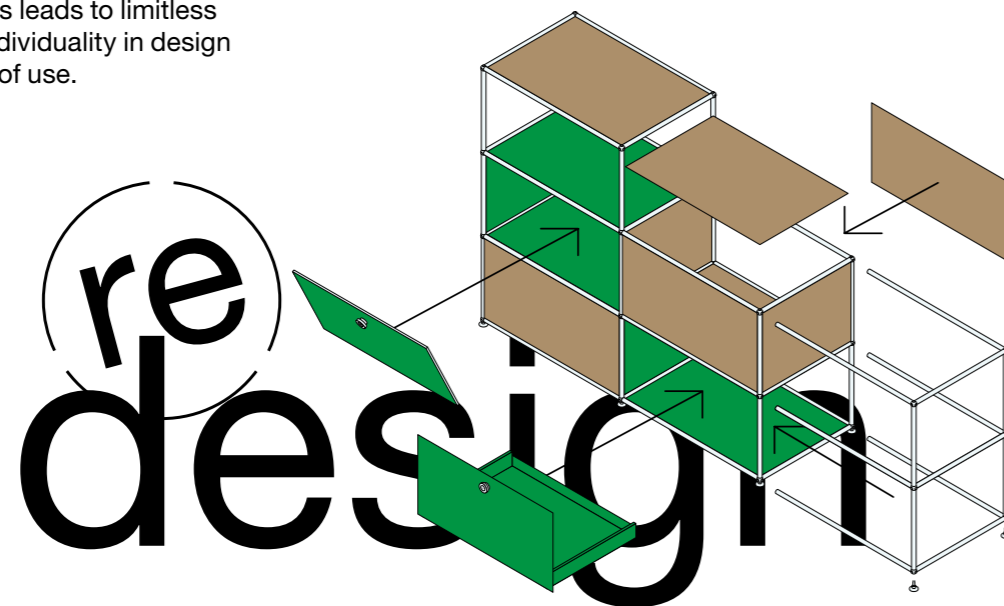

re
design



re
value

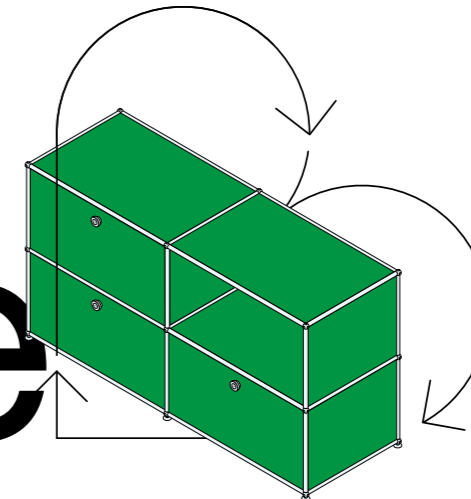

Thanks to the high quality, colours that never fade and a 100% modular system, decades-old USM furniture can be seamlessly combined and upgraded with new components. We believe a product that adapts to your style, your life, your changing needs is relevant and loved.

USM furniture is a valuable companion for life, across generations.



Our product lines USM Haller and USM Kitos M, accounting for more than 92% of our revenue, carry the Cradle-to-Cradle® certification. It is the leading multi-attribute standard used globally across industries for designing and making products that enable a healthy, fair and sustainable future according to the world's most advanced science-based measures.



All our four main product lines carry the UL GreenGuard Certification for low chemical emission. Having undergone rigorous scientific testing to meet stringent emissions requirements, this certification approves that our products contribute to a healthier indoor air quality.

With the Science Based Targets initiative (SBTi), carried by several renowned organisations including the United Nations Global Compact and the the World Wide Fund of Nature (WWF), we have committed to set near-time company-wide emission reductions in line with the latest climate science.

Learn more at www.usm.com/sustainability



USM Haller

The USM Haller system provides a wide variety of elements in standard sizes. Widths, depths and heights are indicated below. All measurements refer to the distance between axes.



Your safety matters to us. Check out the USM safety instructions now. www.usm.com/safety

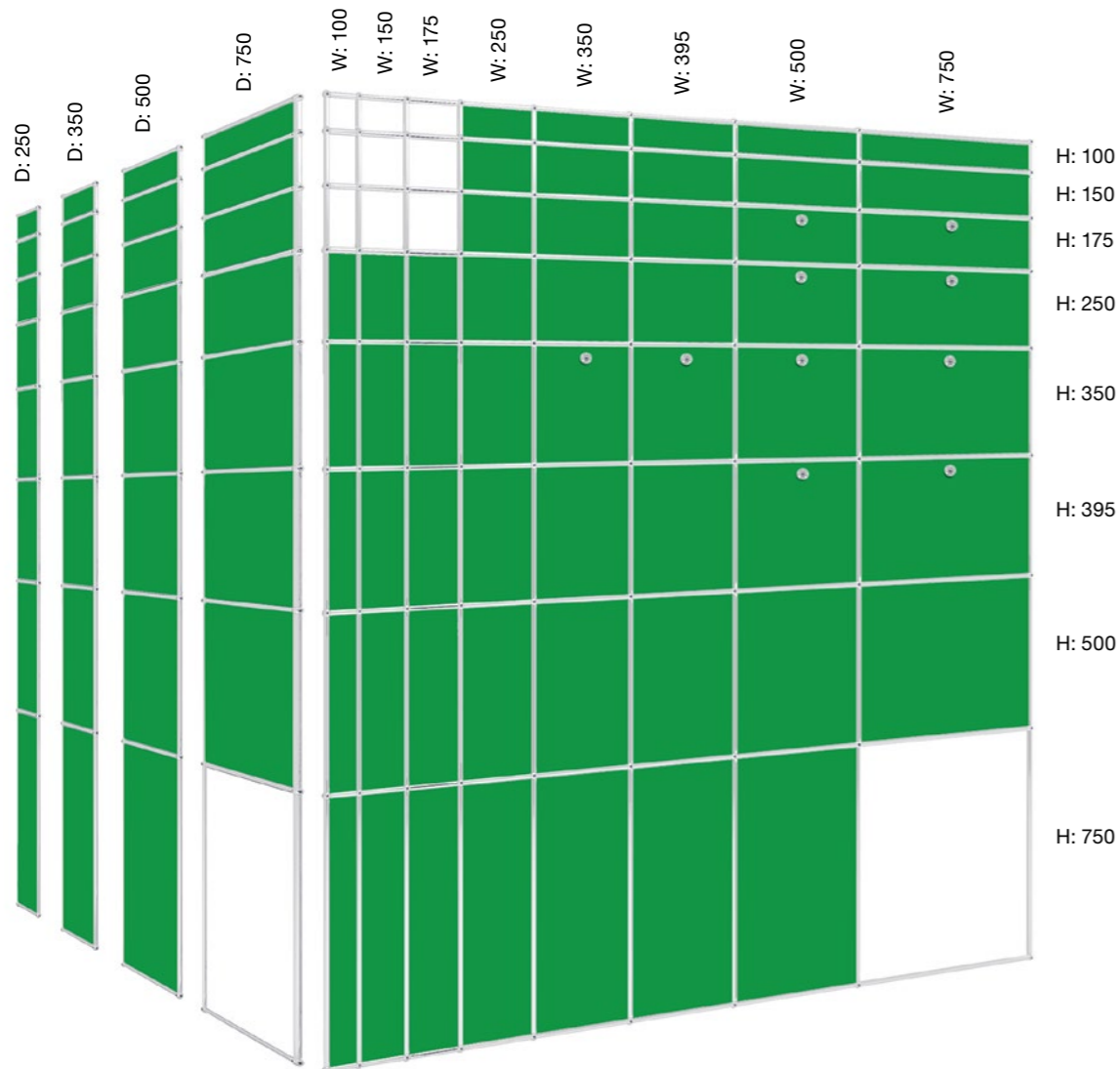
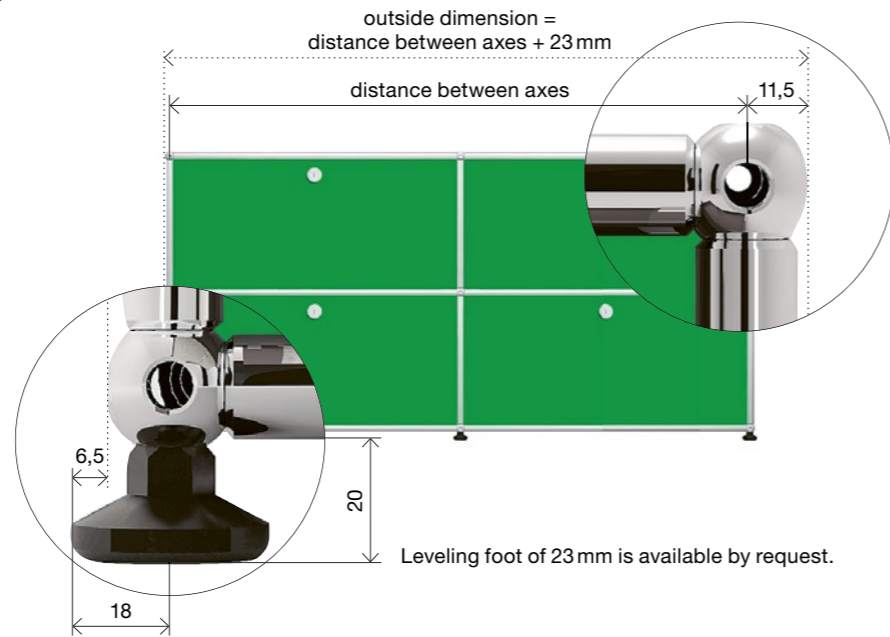

All measurements in mm.

Panels

- 1 Metal panel
- 2 Glass panel
- 3 Acoustic panel
- 4 Perforated metal panel

Doors

- 5 Metal flip-up door*
- 6 Glass door
- 7 Acoustic drop-down door
- 8 Metal drop-down door
- 9 Metal extension door*

Shelves and drawers

- 10 Metal divider shelf
- 11 Glass divider shelf
- 12 Metal extension shelf
- 13 Metal angled shelf
- 14 Extension filing set with extension shelf
- 15 Small drawer D: 500
- 16 A6 drawer D: 500
- 17 A5 drawer D: 500
- 18 A4 drawer D: 500
- 19 Metal plant panel with circular recesses to hold the pots

Accessories

- 20 Hanging file baskets
- 21 Metal box insert
- 21a Slide profile for metal box insert
- 22 Cable cut-out
- 23 Metal magnetic bookend
- 24 USM Inos Box
- 25 USM Inos DVD tray
- 26 USM Inos CD tray
- 27 USM Inos angled file trays
- 28 Bookend for bookshelf panel (D: 350)
- 29 USM Inos, drawer set, open
- 30 USM Inos, drawer set, closed
- 31 USM Inos drawer organiser set



Start configuring your individual piece of USM now! www.usm.com

Illustration: USM Haller in D: 500 mm.

*Acoustic version available. All measurements in mm.

USM Haller E

A modular structure of your design, either completely or partially equipped with e-Balls and e-Tubes, is connected to a source of electricity. The structure itself conducts the low voltage electricity to the desired location using the e-Balls, e-Connectors and e-Tubes to form a circuit. USB chargers or light sources can be snapped into place in pre-cut recesses. The power supply is drawn from any point near the ground. The power supply cable is attached to an e-Ball, and the power adapter is subsequently tucked underneath the furniture until only the operating switch remains visible. From this point the power supply requires no further cables but rather is integrated into the structure of the furniture.

Application Options

- 1 **Glass panel**
Glass elements can be illuminated throughout.
- 2 **Without metal paneling**
Compartments without metal paneling can be completely illuminated.
- 3 **With metal paneling**
Compartments with metal paneling can be illuminated from the front.
- 4 **Compartment with an extension shelf**
The entire compartment with an extension shelf can be illuminated.
- 5 **Drop-down and extension door**
Via the "Light When Compartment Is Open" function, the light automatically turns on when the door is opened.
- 6 **Angled shelf**
The presentation space is illuminated from the front.
- 7 **Floor lighting**
With floor lighting, the light shines at a 25-degree angle under the furniture.
- 8 **Ambient lighting**
The light is directed vertically towards the back, illuminating the surroundings with a warm glow.
- 9 **e-USB charger**
It can be integrated in the same places as the e-Lights.

e-Elements

- 1 **e-Lights**
Dimmable, available in
– Warm white 2700 Kelvin
– Cold white 5700 Kelvin
Both with or without the "light at compartment opening" function.
- 2 **e-USB charger**
Provides a voltage of 5 volts to the connected device. (Capacity: 6.5 W)
- 3 **e-Dummy**
Sleek, black e-Dummy element, closes recesses that are unutilised. Can be changed for additional e-Lights or e-USB charger later.
- 4 **e-Tube (power outlet)**
Tubes with recesses for e-Lights, e-USB chargers or e-Dummy elements that can be easily snapped into place or replaced.

L 350, 1 recess
L 500, 2 recesses
L 750, 3 recesses
- 5 **e-Tube (conductive)**
The conductive e-Tube serves to conduct the electricity if no inserts are desired in this location. It is available in lengths of 750, 500, 395, 350, 250 and 175 mm.
- 6 **e-Ball, e-Connector**
To enable the flow of electricity, the ball and connector were refined. The exterior dimensions remain unchanged. The distinguishing feature of the ball is the black insulation ring.
- 7 **e-Power Supply**
Includes dimmer at the operating switch. Transforms the power supply voltage to 24 volts. (Capacity: 60 W)

CE

Engineered & Made in Switzerland.

Only available in certain countries. Please contact USM Switzerland for availability in your country.



GERMAN DESIGN AWARD WINNER 2019

Winner of the German Design Award 2019 for outstanding design quality in the Office Furniture category



Winner of the Wallpaper® Design Awards 2018



Winner of the Focus Gold Award 2018 for outstanding design quality



Winner of the Muuz International Award 2018 in the furniture category



Winner of the FX Design Awards, Lighting Product 2017

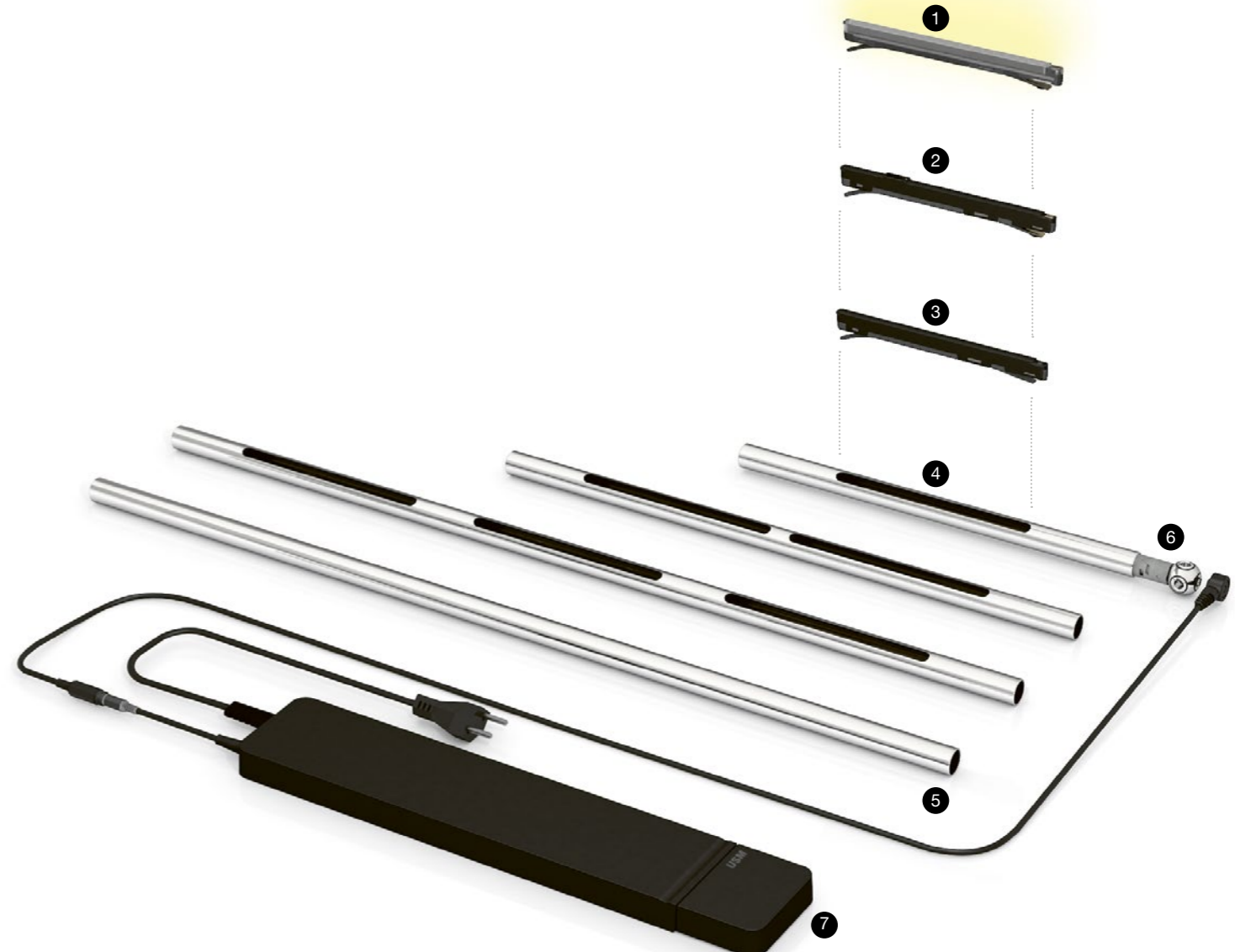
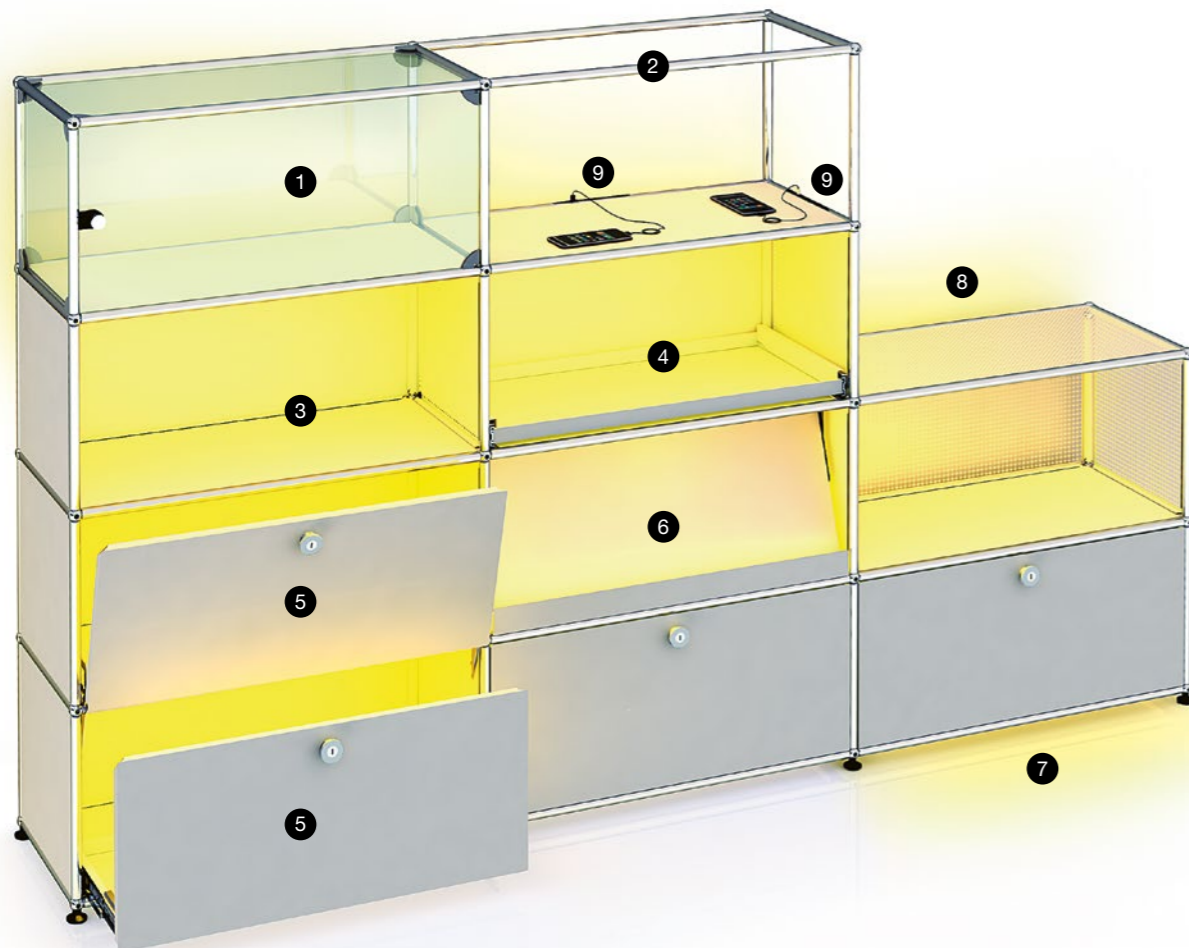

USM Haller table

The USM Haller and USM Haller Plus desk can be equipped with an optional cable basket, while the USM Haller Advanced features integrated smart solutions for electrification. All desks can be equipped with grommet hatches for network access.

Basic table

Optional cable basket underneath the tabletop



USM Haller

H: 740
L: 3000 / D: 1000
L: 3000 / D: 750
L: 2500 / D: 1000
L: 2500 / D: 750
L: 2250 / D: 1000
L: 2250 / D: 750
L: 1000 / D: 1000
L: 750 / D: 750
L: 1250 / D: 500**

H: 740 or 680-860*
L: 2000 / D: 1000
L: 2000 / D: 750
L: 1750 / D: 1000
L: 1750 / D: 750
L: 1500 / D: 1000
L: 1500 / D: 750
L: 1250 / D: 750

Sliding tabletop + adaptation points

Integrated cable tray accessible from above by sliding back the tabletop
Adaptation points for accessories



USM Haller Advanced

H: 740 or 680-860*
L: 2000 / D: 1000
L: 2000 / D: 750
L: 1750 / D: 1000
L: 1750 / D: 750
L: 1500 / D: 1000
L: 1500 / D: 750
L: 1250 / D: 750

Working desk

Optional cable basket underneath the tabletop
Removable adaptation points for accessories



USM Haller Plus

H: 740
L: 3000 / D: 1000
L: 3000 / D: 750

H: 740 or 680-860*
L: 2000 / D: 1000
L: 2000 / D: 750
L: 1750 / D: 1000
L: 1750 / D: 750
L: 1500 / D: 1000
L: 1500 / D: 750
L: 1250 / D: 750

Side table



USM Haller Side table

H: 370
L: 3000 / D: 1000
L: 3000 / D: 750
L: 2500 / D: 1000
L: 2500 / D: 750
L: 2250 / D: 1000
L: 2250 / D: 750
L: 2000 / D: 1000
L: 2000 / D: 750
L: 1750 / D: 1000
L: 1750 / D: 750
L: 1500 / D: 1000
L: 1500 / D: 750
L: 1000 / D: 1000
L: 750 / D: 750

* Optional manual height adjustment with a removable handle.

**Only available in the surfaces pearl grey laminate, black linoleum and Fenix, Grigio Londra
All measurements in mm.

Accessories for all USM Haller desks

- Grommet hatch for network access**
Hatch for a single power outlet, flushmounted in tabletop. This unit can be mounted in two different positions on the tabletop.
- Cable management**
For the Advanced table, a cable tray integrated under the tabletop offers storage room and attachment options for all cables and technical components. For the USM Haller Plus, a cable wire basket can be attached.
- CPU holder**
Computers in various sizes can be mounted using a simple holding device under the table.
- Link chain**
Holds and directs cables to the power source. Flexible and adjustable to different lengths.
- Flat screen support arm**
Screens are mounted onto the support arm (VESA standard). Swivel-type with a spherical joint for the screen. Mounting at different heights is possible for screens weighing up to 12 kg.
- Flat screen pivot arm**
Screens are screwed to the height adjustable pivot arm using a mounting plate (VESA standard). Continuous height adjustment for screens weighing up to 12 kg.
- Front and side panel**
Can be attached under the table to the long side or laterally. For tables with lengths: 2000, 1750, 1500, 1250 and depths: 1000, 750.
- Pivoting pen holder**
Provides room for writing instruments and can be discreetly stowed under the tabletop.
- USM Privacy Panels**
Fitted on the long side of the table to provide individualisation and privacy. H: 350 or H: 700. For tables with lengths: 3000, 2000, 1750, 1500.
- Handle**
With slip clutch for synchronous height-adjustment (optional).

Accessories for USM Haller Plus / Advanced desk

- Flat screen support bar**
The support bar is inserted into the adaptation points. Up to two screens (max. 2 x 12 kg) can be attached using a mounting plate (VESA standard). Screens can be mounted at different heights; screens can be adjusted with ball joints. Continuously height-adjustable for screens weighing up to 12 kg.
 - USB adapter**
The adapter is suitable for USB 2.0 and 3.0 ports. It can easily be inserted into the adaptation point. Usable as power supply or for data transfer.
 - Lamp peg**
An optional lamp peg for easy attachment of selected table lamps. Electrification is possible through the adaptation point.
- Options
- Flat screen support bar fix**
 - Flat screen support bar adjustable**
Move forwards or backwards two notches at a time to adjust the viewing distance.



All measurements in mm.

USM Kitos M and E desk

Each desk of the USM Kitos M and E family offers integrated smart solutions for electrification, excluding free-standing.

Why USM Kitos M?

The "M" in its name stands for mechanical spring-loaded height adjustment; adjustment time approx. 1 second with zero energy consumption. This system is more than 10 times faster than the electronic equivalent and has an extremely long operating life.

Why USM Kitos E?

Maximum functionality and captivating design – USM Kitos E unites all requirements in one modern workplace: continuous height adjustability and maximum stability. A distinction is made between fixed and motor-driven legs in the E1, E2 and E3 models.

E1



H: 740
With or without middle traverse

E2 with 1 motor



H: 700–1200
Adjustment time approx. 30 sec.
With middle traverse

E3 with 2 motors



H: 650–1300
Adjustment time approx. 20 sec.
With middle traverse

Basic desk

Integrated cable tray underneath the tabletop



USM Kitos M

H: 700–1200
L: 1800 / D: 900
L: 1750 / D: 750
L: 1600 / D: 800

USM Kitos E

L: 1800 / D: 900
L: 1750 / D: 750
L: 1600 / D: 800
Available with E1*, E2 or E3** columns

Sliding tabletop

Integrated cable tray accessible from above by sliding back the tabletop

Adaptation points for accessories



USM Kitos M Plus

H: 700–1200
L: 1800 / D: 900
L: 1750 / D: 750
L: 1600 / D: 800

USM Kitos E Plus

L: 1800 / D: 900
L: 1750 / D: 750
L: 1600 / D: 800
Available with E1*, E2 or E3 columns

Extra size

Integrated cable tray underneath the tabletop and accessible from all sides



USM Kitos M Meeting

H: 700–1150
L: 2500 / D: 1000
L: 2250 / D: 1000

USM Kitos E Meeting

L: 2500 / D: 1250
L: 2500 / D: 1000
L: 2250 / D: 1000
Available with E1, E2 or E3 columns

Side table



USM Kitos E Free-standing

H: 740 or 700 – 1110
Square
L: 750 and 900
Round
Ø: 900 and 1100

The table can also be provided with an asymmetrical version of the middle traverse, for extra legroom. (This is not possible with the USM Kitos E / M Meeting.)

* Available with or without middle traverse.

** Available in a GS-Mark tested version with 3 mm table edge radius and the asymmetrical middle traverse.

All measurements in mm.

Accessories for all USM Kitos M and E desks

1 **Grommet hatch for network access**
Hatch for a single power outlet, flush-mounted in table-top. This unit can be mounted in two different positions on the tabletop.

2 **CPU holder**
The CPU holder allows computers of various sizes to be mounted either under the tabletop facing outwards or on the middle traverse facing outwards or inwards as desired.

3 **Link chain**
Holds and directs cables to the power source. Flexible and adjustable to various lengths.

4 **USM Privacy Panels**
Fitted on the long side of the table to provide individualisation and privacy.
H: 350 or 700.
For tables with lengths: 2500, 2250, 1800, 1750, 1600.

Accessories for all USM Kitos M and E desks, except USM Kitos M Meeting / E Meeting

5 **Flat screen pivot arm**
Screens are screwed to the height adjustable pivot arm using a mounting plate (VESA standard). Available for USM Kitos E and M tables: the pivot arm is mounted onto the tabletop using the universal support. Available for USM Kitos M and E Plus: The pivot arm can be inserted into one of the adaptation points with a tube set. Continuous height adjustment for screens weighing up to 12 kg.

6 **Front panel**
Can be attached under the table to the long side or laterally. For tables with lengths: 1800, 1750, 1600.

7 **Material tray**
Provides room for writing instruments and can be discreetly stowed under the tabletop.

Accessories for USM Kitos M Plus / E Plus

8 **Flat screen support arm**
Screens are mounted onto the support arm (VESA standard) which can be connected directly to one of the adaptation points. Swivel-type with a spherical joint for the screen. Mounting at different heights is possible for screens weighing up to 12 kg.

9 **Flat screen support bar**
The bracket is inserted into the adaptation points. Up to two screens (max. 2 x 12 kg) can be attached using a mounting plate (VESA standard). Screens can be mounted at different heights; screens can be adjusted with ball joints.

Options:
9a **Flat screen support bar fix**
9b **Flat screen support bar adjustable**
Move forwards or backwards two notches at a time to adjust the viewing distance.

10 **USB adapter**
The adapter is suitable for USB 2.0 and 3.0 ports. It can easily be inserted into the adaptation point. Usable as power supply or for data transfer.

11 **Lamp peg**
An optional lamp peg for easy attachment of selected table lamps. Electrification is possible through the adaptation point.

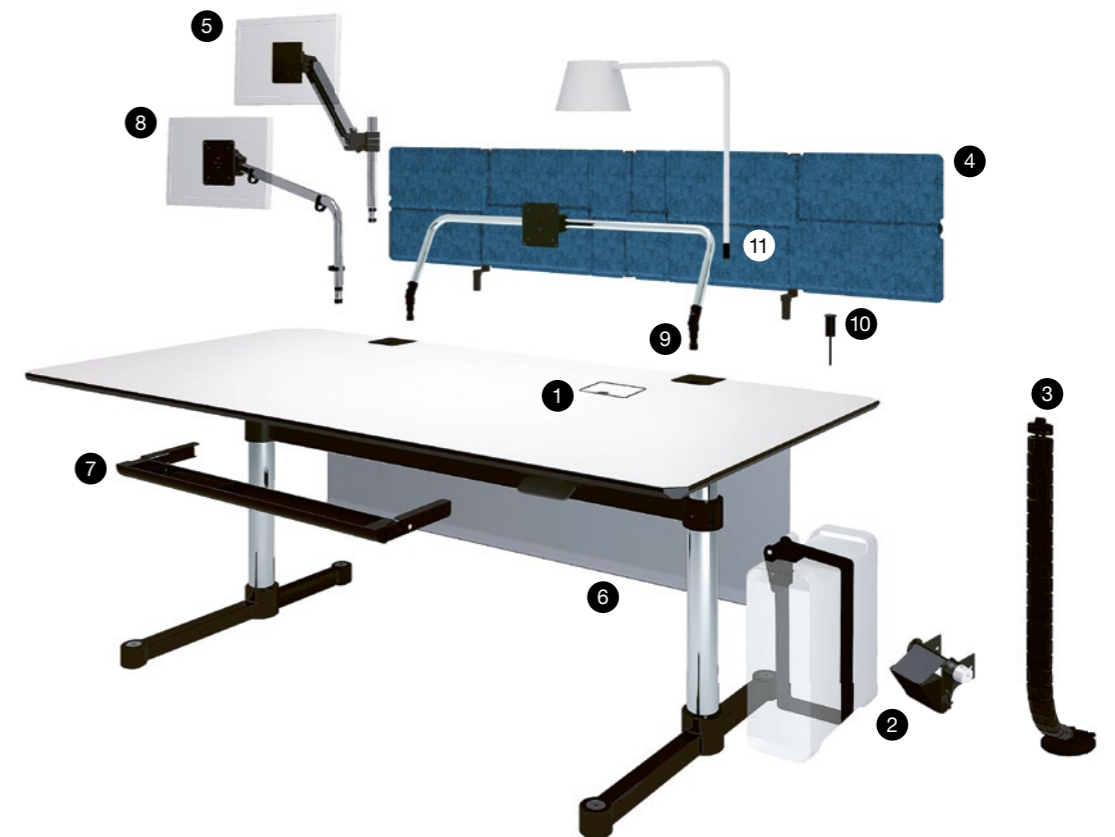

All measurements in mm.

USM Kitos desk

Available at a fixed height, with incremental or free-flow height adjustment, which can be adjusted electronically.

Rectangular



USM Kitos Rectangular

H: 740
L: 1800 / D: 900
L: 1750 / D: 750
L: 1500 / D: 750
L: 900 / D: 750

Stepwise height adjustment
H: 680–780 / 1060
L: 1800 / D: 900
L: 1750 / D: 750
L: 1500 / D: 750
L: 900 / D: 750

Continuous height adjustment
H: 700–1200*
L: 1800 / D: 900
L: 1750 / D: 750
L: 1500 / D: 750
L: 900 / D: 750

Side table



USM Kitos Free-standing

H: 740
Square
L: 900, 750
Round
Ø: 1100, 900

Stepwise height adjustment
H: 680–780 / 1060
Square
L: 750
Round
Ø: 900
Rectangular
L: 900 / D: 750

Continuous height adjustment
H: 680–1090*
Square
L: 750
Round
Ø: 900

Accessories for all USM Kitos classic desks

- 1 **Universal support**
Is mounted directly onto the tabletop to hold various accessories.
- 2 **Flat screen pivot arm**
Screens are screwed to the height-adjustable pivot arm using a mounting plate (VESA standard). The pivot arm can be mounted onto the tabletop using the universal support (1). Continuously height-adjustable for screens weighing up to 12 kg.
- 3 **Cable duct**
A black aluminum cable duct section, with lids that fold open on both sides, to integrate power strips and cables. The table depths can thereby be expanded to the EU standard of over 800 mm. For tables with lengths: 1800, 1750, 1500, 900.
- 4 **USM Privacy Panels**
Fitted on the long side of the table to provide individualisation and privacy.
H: 350 or H: 700.
For tables with lengths: 1800, 1750, 1500.
- 5 **Link chain**
Holds and directs cables to the power source. Flexible and adjustable to various lengths.
- 6 **CPU holder**
Height is adjustable width can be varied using a Velcro band. This allows differently sized computers to be installed.
- 7 **Cable wire basket**
For the cable management a cable wire basket can be used. It is hung under the tabletop out of sight.
- 8 **Material tray**
Provides room for writing instruments and can be discreetly stowed under the tabletop.



*Not available in glass.
All measurements in mm.

All measurements in mm.

USM Privacy Panels

USM Privacy Panels are a flexible and extendable modular system made up of individual panel units. Each panel unit consists of two layers of molded polyester fabric with a tubular cross-beam. They can be used in a free-standing version or mounted on tables to divide up the work space, ensure privacy and absorb unwanted noise.



The panels are available in two sizes, a smaller version measuring 250 x 350 mm and a larger version measuring 750 x 350 mm. These dimensions are chosen to match those of the USM Haller system and tables as well as USM Kitos desks. All measurements refer to the distance between axes.

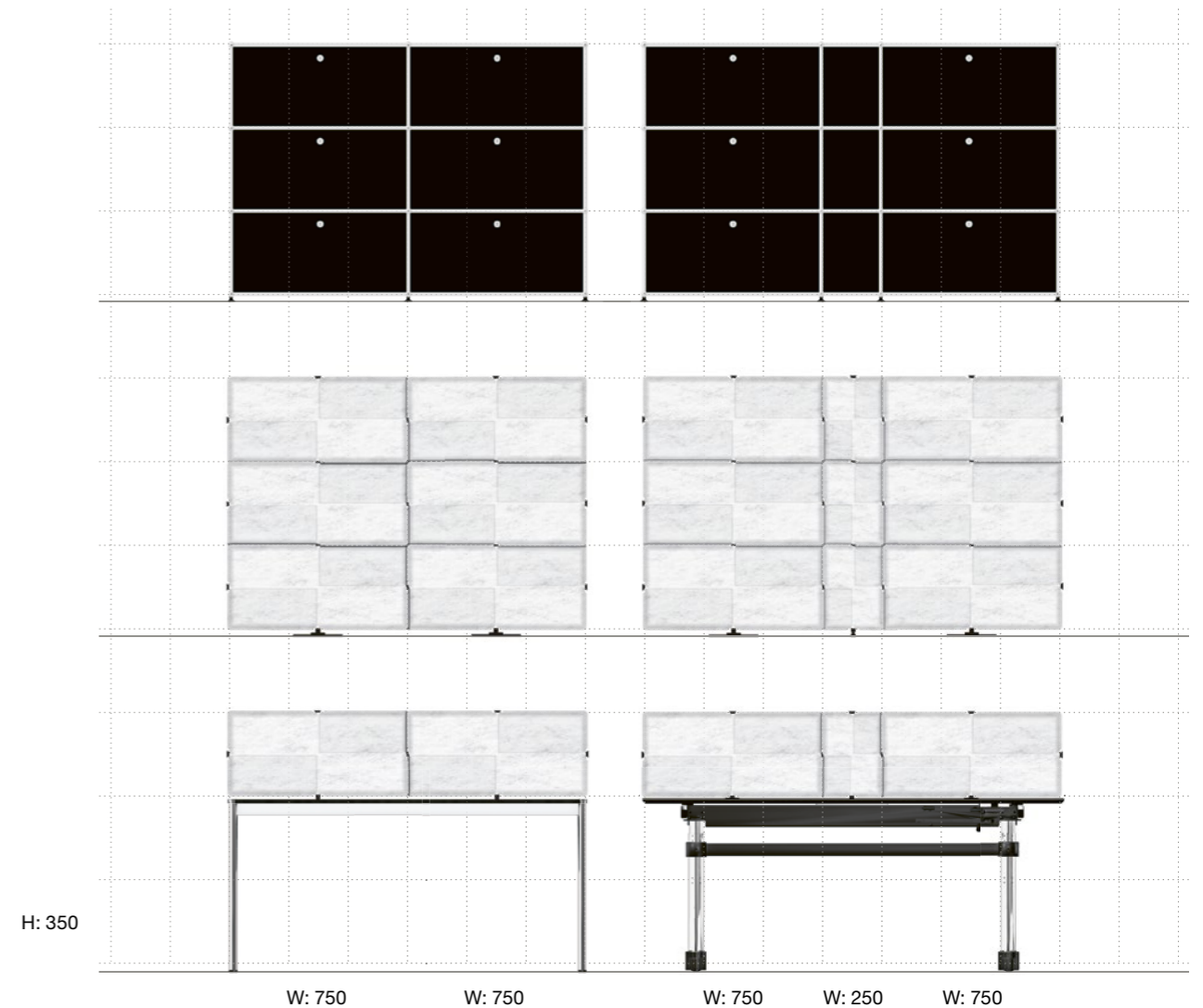
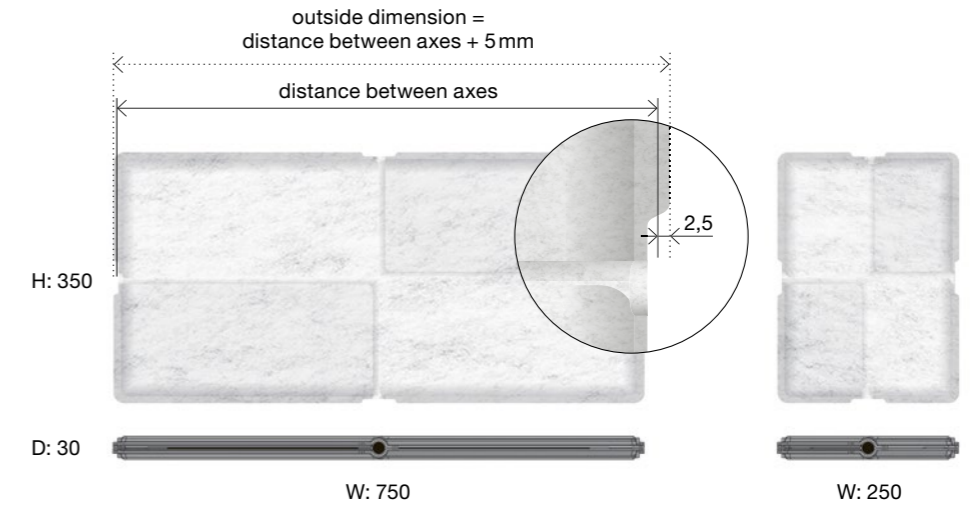

All measurements in mm.

Colours & surfaces

USM Haller



Metal



USM Haller and USM Kitos tables



Powder-coated MDF

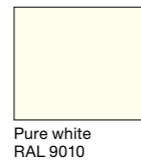

Trans-parent glass

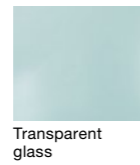

Linoleum

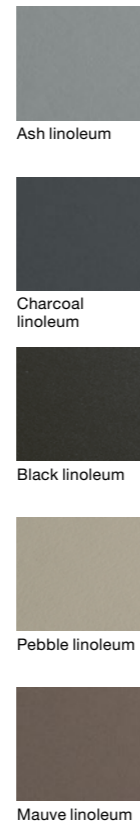

Laminate

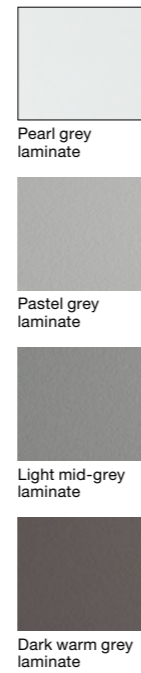

Fenix



Oiled or lacquered veneer

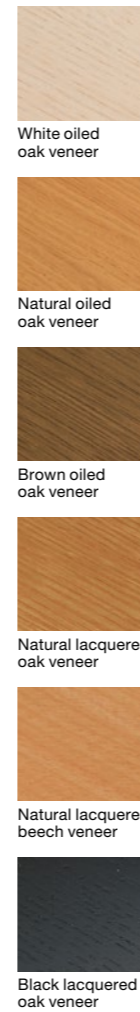

USM Privacy Panels



Fabric panel



USM Inos box



Fabric panel

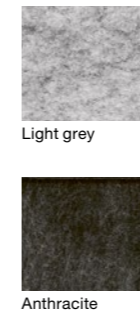

USM Inos drawer set



Metal



Pots



Clay

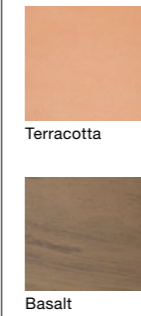

Details

USM Haller



Metal

USM Haller table

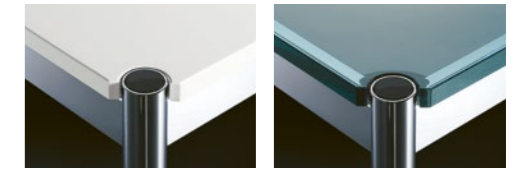

Powder-coated MDF

Transparent glass



Linoleum

Laminate

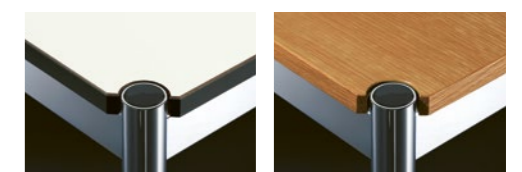

Fenix

Oiled or lacquered veneer

USM Kitos table

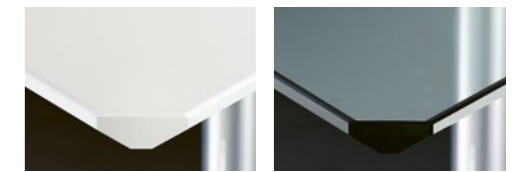

Powder-coated MDF

Transparent glass



Linoleum

Laminate

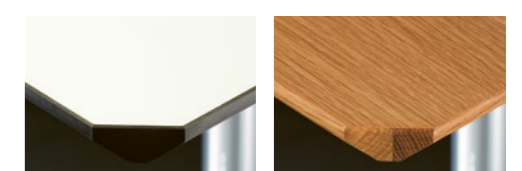

Fenix

Oiled or lacquered veneer

Other colours and surfaces available upon request. Prices and delivery times of table surfaces upon request.

The tabletop in glass is only available for USM Haller desks up to L: 2000 mm and all USM Kitos desks with a fixed height (H: 740 mm) or stepwise height adjustment and continuous height adjustment (H: 680 - 780 / 1060 mm).

The following options are available in graphite black and pure white only: USM Inos drawer set, 5 drawers, open USM Inos drawer set, 10 drawers, closed USM Inos drawer set, 10 drawers, open



Switzerland

USM U. Schärer Söhne AG
Thunstrasse 55, 3110 Münsingen
Phone +41 31 720 72 72, info.ch@usm.com

Germany

USM U. Schärer Söhne GmbH
Siemensstraße 4a, 77815 Bühl
Phone +49 7223 80 94 0, info.de@usm.com

France

USM U. Schärer Fils SA, Showroom
23, rue de Bourgogne, 75007 Paris
Phone +33 1 53 59 30 37, info.fr@usm.com

United Kingdom

USM U. Schaerer Sons Ltd., London Showroom
Ground Floor, 49–51 Central St., London, EC1V 8AB
Phone +44 207 183 3470, info.uk@usm.com

USA

USM U. Schaerer Sons Inc., New York Showroom
28–30 Greene Street, New York, NY 10013
Phone +1 212 371 1230, info.us@usm.com

Japan

USM U. Schaerer Sons K.K., Tokyo Showroom
Marunouchi MY PLAZA 1 · 2F
2-1-1 Marunouchi, Chiyoda-ku, Tokyo 100-0005
Phone +81 3 6635 9420, info.jp@usm.com

All other countries
contact USM Switzerland.

www.usm.com

